

Lowstand deltas in the Frontier Formation, Powder River basin, Wyoming: Implications for sequence stratigraphic models

Janok P. Bhattacharya and Brian J. Willis

ABSTRACT

Deposits of lowstand deltas formed on the floor of the Cretaceous Interior seaway of North America are found in the Cenomanian, lower Belle Fourche Member of the Frontier Formation, central Wyoming. Sandstones located in similar distal basin locations, hundreds of kilometers basinward of highstand shoreline deposits, form important hydrocarbon reservoirs isolated within marine shales, but interpretation of their origin has been highly controversial. The distribution, geometry, and internal facies of these sandstones are documented by an extensive outcrop study and regional subsurface correlations to develop genetic facies models for these deposits. This integrated record of lithofacies, ichnofacies, palynofacies, paleocurrent data, bedding relationships, and isolith maps incorporates observations from nearly 100 measured outcrop sections and about 550 subsurface well logs.

Four episodes of sediment progradation and subsequent transgression each left behind gradually upward-coarsening deltaic sandstones that have eroded tops. These deltaic sandstones have a lobate to elongate geometry, basinward-dipping internal clinof orm bedding, radiating paleocurrents, a low to moderate degree of shallow-marine burrowing, and show variable wave influence and tidal influence on deposition. Delta plain, paralic, and nonmarine facies have been eroded from the top of deltaic successions. Erosion surfaces capping progradational deltaic successions are the only stratal discontinuities that can be mapped regionally, and they appear to record transgressive ravinement enhanced over areas of structural uplift, compared with lowstand surfaces of erosion, which record the bypass of sediments basinward. Low accommodation during lowstands left little room for sandstones to stack vertically, and successive episodes of delta progradation were offset along strike. More tide-influenced delta deposits formed within shoreline embayments

AUTHORS

JANOK P. BHATTACHARYA ~ *University of Texas at Dallas, Geosciences, P. O. Box 830688, FO 21, Richardson, Texas, 75083; janokb@utdallas.edu*

Janok P. Bhattacharya is associate professor in geology at the University of Texas at Dallas (UTD). His research interests include deltaic sequence stratigraphy, the local control of structure on stratigraphy and reservoir architecture of clastic depositional systems. He received his B.Sc. degree in 1981 from Memorial University of Newfoundland, Canada, and Ph.D. in 1989 from McMaster University, Hamilton, Ontario, Canada. Following a Natural Sciences and Engineering Research Council postdoctoral fellowship at the Alberta Geological Survey in Edmonton, Janok worked for the Bureau of Economic Geology at Austin and ARCO before joining UTD.

BRIAN J. WILLIS ~ *State University of New York at Oswego, Department of Earth Sciences, Oswego, New York, 13126; bwillis@oswego.edu*

Brian Willis received a B.S. degree from the University of Minnesota and an M.S. degree and Ph.D. from Binghamton University. Following a postdoctoral fellowship at the Smithsonian's Natural History Museum, Brian was employed as a research scientist at the University of Texas. He is presently a visiting assistant professor at SUNY-Oswego. An early interest in fluvial systems led to studies of long fluvial successions exposed in Devonian strata of New York and Miocene strata of Pakistan. Later Brian studied several stratigraphic units deposited on shorelines of the Cretaceous Western Interior seaway of North America. His current interests include understanding sequence stratigraphic controls on deposition and quantifying sedimentologic variations to predict reservoir heterogeneity.

Copyright ©2001. The American Association of Petroleum Geologists. All rights reserved.

Manuscript received May 27, 1999; revised manuscript received March 28, 2000; final acceptance June 30, 2001.

ACKNOWLEDGEMENTS

This research is a product of the Clastic Reservoirs Group at the Bureau of Economic Geology, University of Texas at Austin, sponsored by Amoco/BP, Chevron, Conoco, Exxon, In-tevep, Japan National Oil Company, Maxus, Occidental, Oryx, Saga, Statoil, and Unocal. Sharon Gabel, Chris Swezey, and Charl Broquet assisted in the field; Qing Fang, Matt Uliana, and Yugong Gao helped assemble the data. We thank ranchers in the Kaycee, Wyoming, area for logistical help and access to their private lands. Nicholas Christie-Blick and Kenneth G. Miller reviewed an earlier draft, and we thank Randi Martinsen and A. Guy Plint for their constructive reviews of this version.

defined by the topography of older wave-influenced delta lobes and subtle syndepositional deformation of the basin floor.

Standard sequence stratigraphic terminology is difficult to use in broad lowstand systems like the Frontier Formation because sandstones do not show simple vertical stacking patterns, major stratal discontinuities can form by processes other than lowstand fluvial erosion, and minor syndepositional deformation of the basin floor exerts a first-order influence on depositional and sediment preservation patterns. Although many basin-distal sandstones have been interpreted to be deposits of offshore bars, shelf-isolated valley fills, and stranded shorelines, the Frontier Formation examples documented here suggest that many of these deposits may be top-eroded deltas formed where rivers delivered sediment to lowstand coastlines. The external geometry and internal heterogeneities of hydrocarbon reservoirs found in these types of deposits reflect processes active on the low accommodation deltaic shoreline, even in cases where subsequent ravinement has significantly truncated the deposits during transgression.

INTRODUCTION

The origin of distal shelf sandstones deposited near the center of the Cretaceous Interior seaway of North America has long been controversial (e.g., Walker, 1984, 1990; Swift et al., 1995; Johnson and Baldwin, 1996; Snedden and Bergman, 1999). Isolated marine sandstones are significant hydrocarbon reservoirs in the distal parts of many shallow-marine basins worldwide, and better genetic models of these sandstones are needed to improve exploration strategies and economic exploitation of discovered resources. Different genetic models proposed to explain the occurrence of these distal-basin sandstones led to contrasting predictions of reservoir distribution, geometry, and the laterally changing character of internal heterogeneities.

Early students of Cretaceous seaway stratigraphy recognized that distal-basin sandstones were isolated from basin-margin sandstone wedges, and they suggested that these distal-basin sandstones formed by growth of marine sand ridges or offshore bars (Berg, 1975; Brenner, 1980; La Fon, 1981; Palmer and Scott, 1984; Rice, 1985; Tillman and Martinsen, 1985; Winn, 1991). More recent studies questioned mechanisms proposed to deliver sands to deeper water marine environments (e.g., geostrophic storm currents and prodelta-shelf plumes) and suggested that episodic shoreline regressions and subsequent transgressions were required to form distal-basin sandstones (e.g., Plint, 1988; Walker, 1990; Scheihing and Gaynor, 1991; Hunt and Tucker, 1992; Posamentier et al., 1992; Walker and Bergman, 1993; Bergman, 1994; Bhattacharya and Posamentier, 1994). Those who argue for the formation of sandstones by pronounced changes in shoreline position disagree widely on the mechanisms of sandstone deposition and the genesis of important stratigraphic surfaces. Depositional interpretations of

the same reservoir sandstones have varied as dramatically as offshore bars, stranded shoreface deposits, and fluvially incised valleys (e.g., see articles addressing depositional interpretations of the Shannon Sandstone of Wyoming by Swift et al. [1995] and Snedden and Bergman [1999] and addressing formation of the Toci sandstone of New Mexico by Jenette and Jones [1995] and Nummedal and Riley [1999]).

In many cases it is difficult to distinguish facies successions formed in different shoreline and shallow-marine environments based solely on isolated vertical outcrop sections, cores, or well logs. Consequently, tests to distinguish different depositional models for these sandstones generally require that observations be collected within a well-defined stratigraphic framework. The distribution of sandstones in distal-basin areas can be complex and laterally variable, sandstone stacking commonly does not follow simple patterns recognized in highstand areas of the basin, and closely associated sandstones can have different shapes, lateral extent, and facies. Because of these lateral complexities, proposed depositional models clearly need to be based on extensive data sets that demonstrate facies patterns, sediment body geometries and internal stratal architecture, and the correlation of key stratigraphic surfaces across a broad three-dimensional area.

Some investigators still consider sands deposited on offshore bars to be an important play type in distal areas of the Cretaceous foreland basin of Wyoming and elsewhere (e.g., Parker, 1999). Newer studies, however, increasingly evoke more complex sequence stratigraphic controls on sandstone deposition and preservation in distal-basin locations when interpreting these reservoir sandstones. Debate on the genesis of distal-basin sandstones has centered on a few examples formed in the Cretaceous Interior seaway because there is abundant core and well data in this mature petroleum province. In addition, these deposits can be viewed in closely associated outcrops exposed along areas of Laramide uplift. Because extensive focus on a few well-documented examples of distal-basin sandstones within the Cretaceous Interior seaway by multiple investigators has not led to a consensus in depositional interpretations, detailed documentation of other examples is clearly needed before generalized depositional and sequence stratigraphic models can be advanced.

This article examines distal-basin sandstones of the Frontier Formation exposed along the margin of the Powder River basin in central Wyoming. Like many other reservoirs, these Frontier sandstones have

been variably interpreted as offshore shelf ridges (Tillman and Merewether, 1994), truncated shorefaces, prodelta plumes (Barlow and Haun, 1966; Merewether et al., 1979) and fluvially incised tide-dominated estuarine valley fills (Tillman and Merewether, 1994, 1998). Our goal is to evaluate these different interpretations by examining the vertical and lateral facies changes of sedimentary bodies traced across outcrops and correlated throughout an extensive subsurface data set in greater detail than has been attempted before. This regional stratigraphic framework is used to evaluate and refine depositional and stratigraphic interpretations of these deposits within the context of more general sequence stratigraphic models proposed to explain the occurrence and distribution of sandstones preserved in distal-basin areas of the Cretaceous Interior seaway.

REGIONAL SETTING

The Frontier Formation is a Cenomanian to Turonian (Upper Cretaceous) clastic wedge that prograded east and southeastward away from the Sevier orogenic belt into a foreland basin (Figure 1a). The Frontier Formation is sandwiched between the thick marine underlying Mowry and overlying Cody shales (Figure 2). Proximal Frontier deposits, exposed in western Wyoming and eastern Utah, are a thick succession of non-marine facies including conglomeratic fluvial deposits cut locally into marine shoreface deposits (Hamlin, 1996). These fluvial conglomerates have been interpreted to be fills of incised valleys that bypassed sediment past highstand shorelines to basin areas farther east (Hamlin, 1996). Several hundred kilometers to the east, along the edge of the Powder River basin in central Wyoming (Figure 1b), the Frontier Formation comprises dominantly marine strata that have been divided into three unconformity-bounded members: Belle Fourche, Emigrant Gap, and Wall Creek (Figures 2, 3). Merewether et al. (1979) showed that members are composed of a variable number of sandstone bodies separated by marine shales (Figure 3). We focus on the basal part of the Belle Fourche Member in the Powder River basin, including sandstones 1 and 2 of Merewether et al. (1979). Although there is no active production from the lower Belle Fourche, these strata provide an important outcrop and subsurface analog to productive sandstones elsewhere in this and similar basins. Most Frontier production is from the Wall Creek and upper Belle Fourche sandstones.

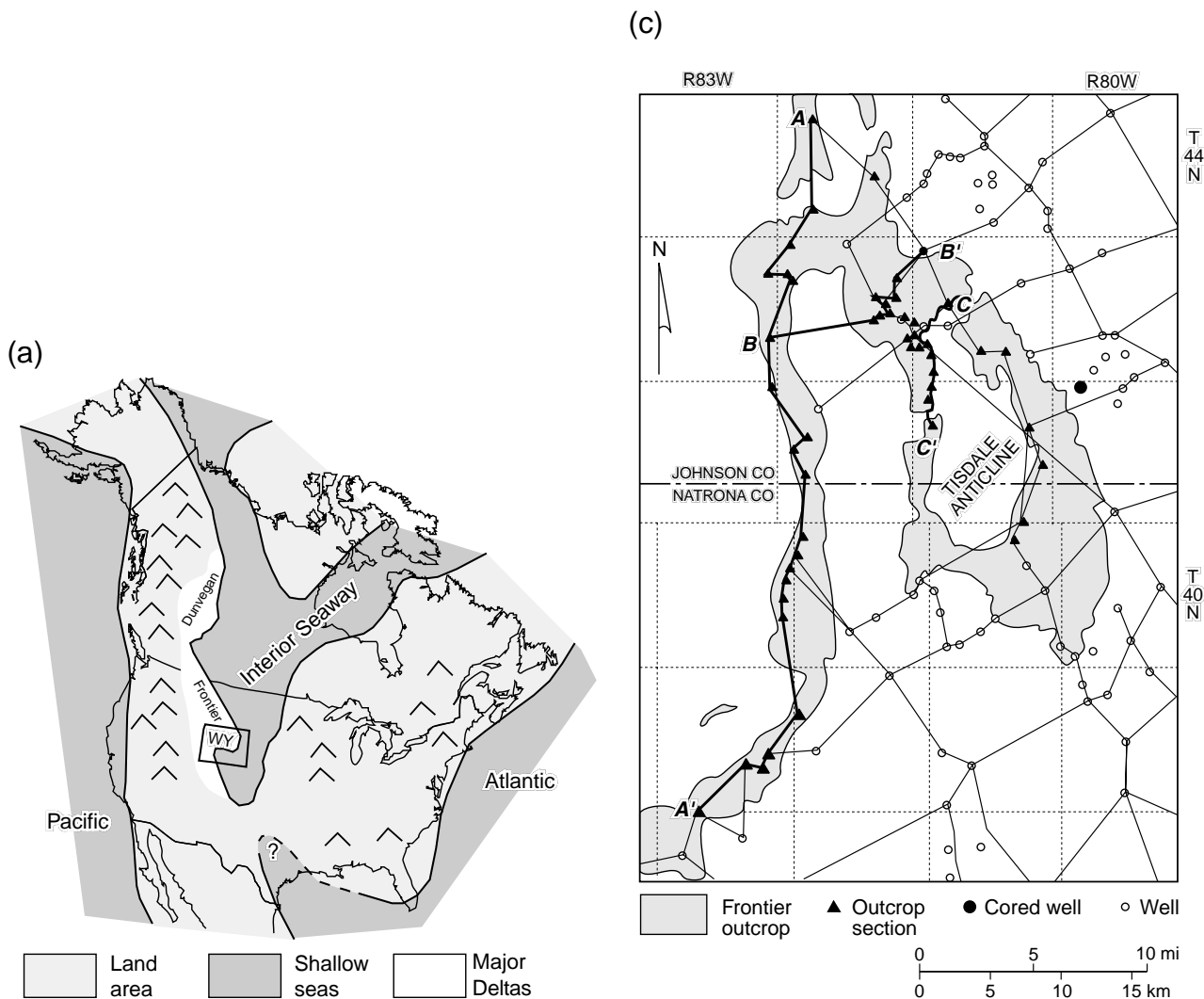

Figure 1. (a) Paleogeographic map showing Cenomanian seaway and major deltaic complexes of the Frontier and Dunvegan formations in the United States and Canada. WY, Wyoming. Map compilation based on Williams and Stelck, 1975; Tillman and Merewether, 1994; and Dyman et al., 1994. (b) Detailed location map of subsurface cross sections, well control, and Frontier Formation outcrops (c) Area around the Tisdale anticline showing outcrop cross sections and well control. U.S. Geological Survey 2 Bailey Flats cored well is at the northeast end of cross section BB'.

Although the exact geometry of the foreland basin during Frontier deposition is not well known, the sandstones in this article were clearly deposited on the gently sloping floor of the distal part of the foreland basin, far from the rapidly subsiding areas directly adjacent to the orogenic belt. Theoretical models suggest a peripheral bulge may have lain about 100–300 km basinward of the orogenic belt, depending on the flexural rigidity of the lithosphere (e.g., Beaumont, 1981; Jordan and Flemmings, 1991). Thus, these sandstones may have spilled out over a peripheral bulge of an overfilled foreland basin to the west and rapidly prograded across the lower accommodation margins of the sea-

way to the east. The interval studied, termed here the lower Belle Fourche Member, includes the lowest 75 to 150 m of the Frontier Formation. The interval starts at the Clay Spur Bentonite dated 97.17 ± 0.69 Ma (Obradovich, 1993) and ends at a bentonite dated at 95.78 ± 0.61 Ma (Obradovich, 1993). Thus the deposits formed over about 1.4 million years during the early part of the Cenomanian age. The oldest ammonites within the Frontier Formation belong to the *Conlinoceras tarrantense*–*Calycoceras gilberti* zone and were found directly above the bentonite capping the interval studied (Figure 3). These ammonites, termed the “Thatcher Fauna,” have been associated with opening

(b)

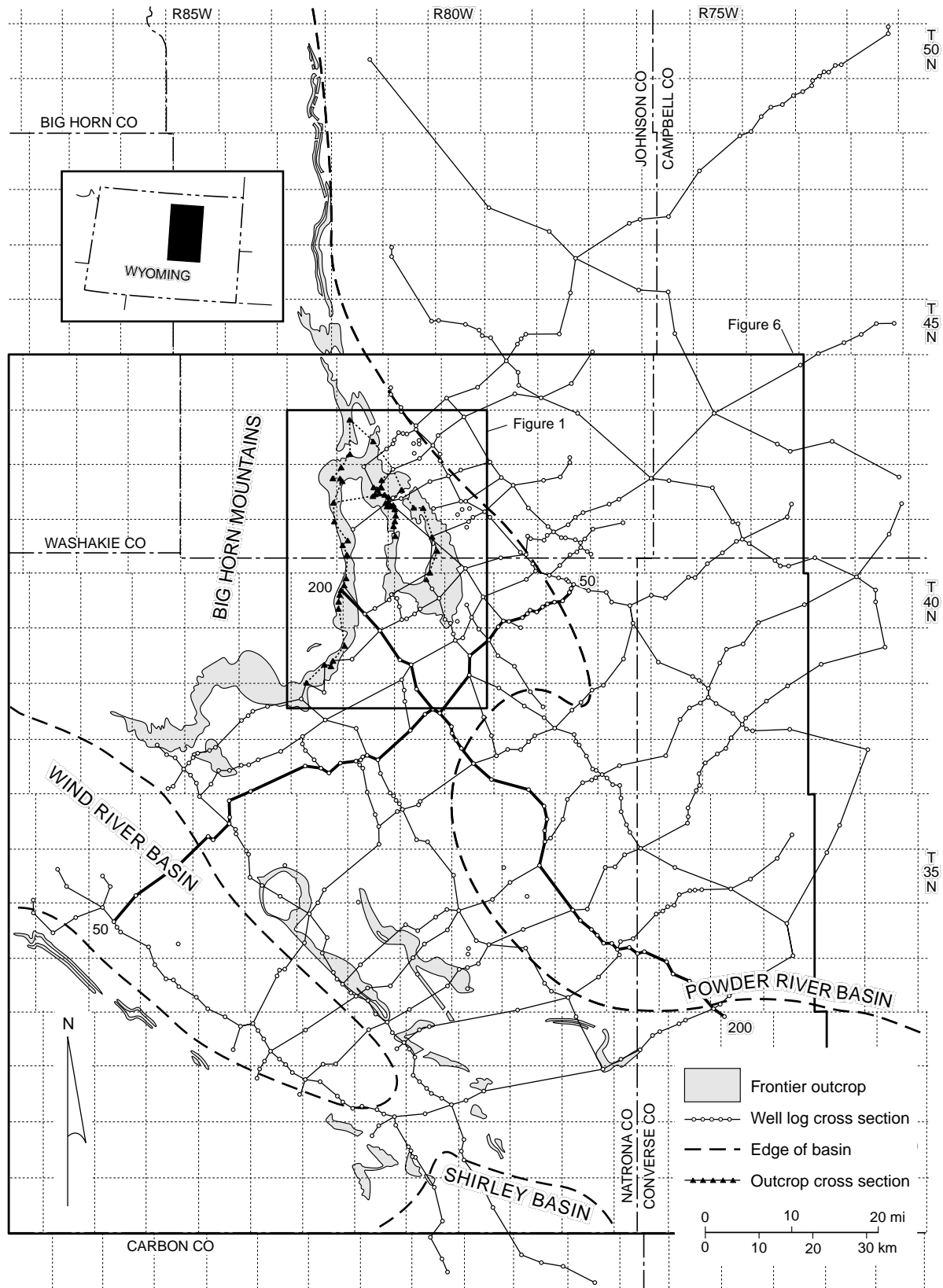

Figure 1. Continued.

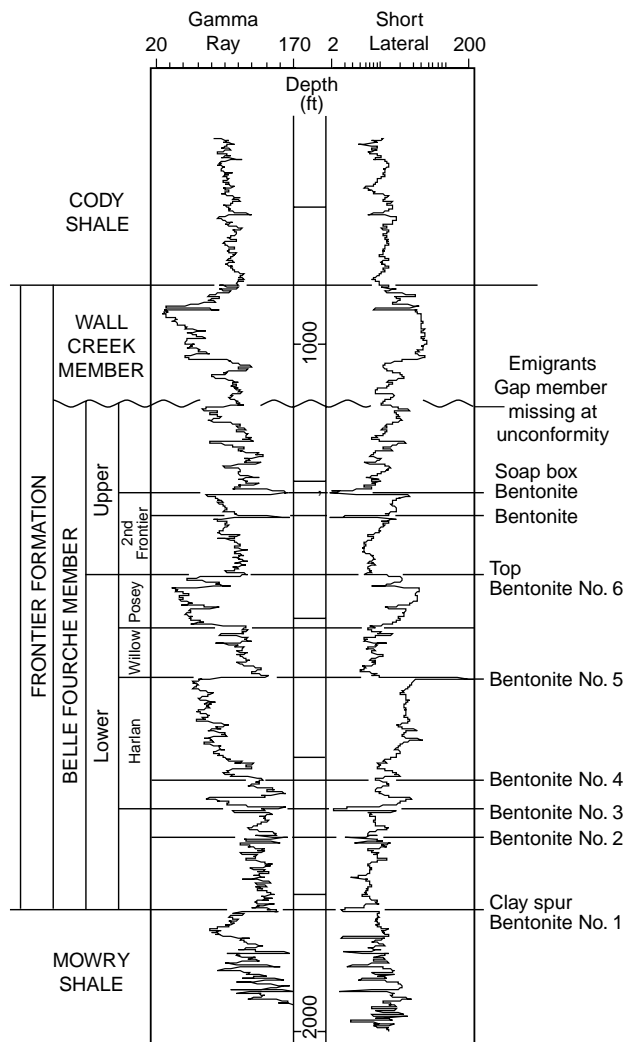

Figure 2. Type log through the Frontier Formation showing stratigraphy and major bentonites (located at Sec. 2, T36N, R85W). Emigrant Gap member is missing at basal Wall Creek unconformity (see Figure 3).

of the seaway and flooding of the transcontinental arch by warmer Tethyan waters from the ancestral Gulf of Mexico (Figure 1a) (McGooky et al., 1972; Cobban et al., 1994; Tillman and Merewether, 1994).

SEDIMENTOLOGY AND ALLOSTRATIGRAPHY

The lower Belle Fourche Member is exposed along the uplifted eastern flank of the Big Horn Mountains and around the margins of Tisdale anticline (Figures 1b, c).

Six meter-thick, bentonite beds were correlated within the lower Belle Fourche, through 50 outcrop sections and 550 well logs, to produce a grid of isochronous surfaces spanning about 25,000 km² (Figure 1b, c). Excellent exposures allowed the tracing of lithologic variations and important stratigraphic surfaces across the outcrop belt (Figure 4). Subsurface correlation of lithologic variations was based primarily on resistivity logs because gamma logs were scarce and spontaneous potential log response was poor (Figure 5). Four regionally extensive, upward-coarsening stratigraphic units were recognized in outcrop and extrapolated into the subsurface using the alignment of log trends. Overlap relations of sandstone bodies observed in outcrop were also used as a guide to determine whether sandstone bodies should be correlated as continuous sheets or as more isolated lenses (Figures 4, 5).

Where thickest, stratigraphic units are tens of meters thick and grade upward from marine shales into sandstone bodies, which are in turn capped by a coarse-grained lag. Gradual upward coarsening within these stratigraphic units suggests shales are genetically related to overlying sandstones. In contrast, sandstone-capping lags clearly overlie erosion surfaces and are in turn abruptly overlain by deeper marine mudstones, suggesting they mark stratigraphic discontinuities. The division of the lower Belle Fourche Member into four internally conformable stratigraphic units separated by bounding discontinuities defines allomembers (cf., NACSN, 1983; Walker, 1990; Bhattacharya and Walker, 1991; Bhattacharya, 1993; Blum, 1993; Posamentier and James, 1993; Bhattacharya and Posamentier, 1994). From oldest to youngest these are named the Harlan, Willow, Frewens, and Posey allomembers. The Harlan allomember is the Kf1 sandstone described by Merewether et al. (1979). The Willow, Frewens, and Posey allomembers are mappable subdivisions within the Kf2 sandstone described by Merewether et al. (1979). The Frewens allomember was previously named the Frewens Castle sandstone by Tillman and Merewether (1998).

The evolution of depositional environments is interpreted from allomember thickness variations, spatial transitions between internal genetically related facies, interpretation of depositional processes active during sediment aggradation, trace fossils, and micro-paleontology. Sandstone thicknesses, observed in outcrop and estimated from well logs, were used to hand-contour sandstone isolith maps for each allomember (Figure 6). The origin of discontinuities separating allomembers is interpreted from the clast composition

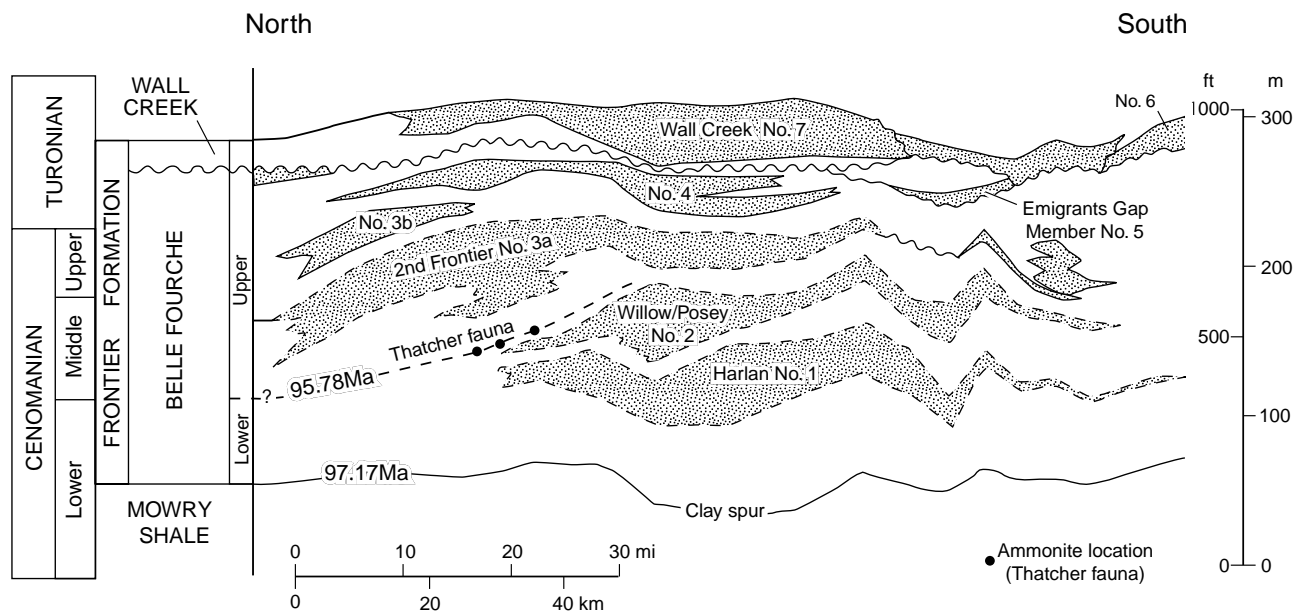

Figure 3. North-south cross section parallel to the Frontier outcrop belt shown in Figure 1b and extending from the Powder River into the Wind River basin (location in Merewether et al., 1979). Eight major sands have been grouped into three members. Sandstones 1 and 2 represent the units examined in greater detail for this study. The additional data in this study demonstrate that the sandstone 2 is older than the Thatcher fauna, not younger as originally shown by Merewether et al. (1979).

of associated lags and lateral changes in their stratigraphic position relative to facies changes and isochronous bentonite beds.

The shale-dominated lower parts of allomembers are similar, so we describe and interpret these deposits together first. We then present descriptions of the four allomembers individually to emphasize thickness trends and facies differences within the enclosed sandstone bodies. Finally, we present comparisons of the different allomembers and interpretations of large-scale variations across them.

Shale-Dominated Intervals

Mudstones are laminated to thinly bedded, variably bioturbated shales and siltstones arranged in meter-thick upward-coarsening bedsets. Bedsets lower in allomembers can start with nearly black, laminated shale that grades upward into more bioturbated gray silty shale. These shales in turn grade upward into bioturbated shaly siltstones having thin-bedded wave-rippled sandstones. Bentonite beds occur preferentially near the base of some of these upward-coarsening bedsets; six of these bentonites were thick enough to be correlated regionally.

Bioturbation is by small diameter *Zoophycos*, *Asterosoma*, *Palaeophycos*, *Planolites*, *Terebellina*, and uncommon *Helminthopsis* and *Skolithos* burrows. These define a *Zoophycos* to *Cruziana* ichnofacies assemblage interpreted to be typical of a marine shelf, although the stunted trace fossils suggest stressed and possibly brackish conditions in the seaway (cf. Pemberton et al., 1992; Pemberton and Wightman, 1992). Dinoflagellates, collected from these mudstones, indicate marine conditions, although a lack of calcareous foraminifera and the presence of terrestrially derived spores and pollen corroborate brackish conditions and possibly proximity to a river (R. Curry, 1995, personal communication).

Harlan Allomember

Sandstones of the Harlan allomember (named after Harlan Ranch where it is well exposed) are nearly 55 m thick in the southern end of the outcrop belt and have a broadly lobate shape that extends 100 km to the southeast in which direction they thin into mudstones (Figures 4, 5, 6a). Where it is thickest (at Big Sulfur Draw) (Figures 7, 8a), the Harlan allomember contains three upward-coarsening facies successions,

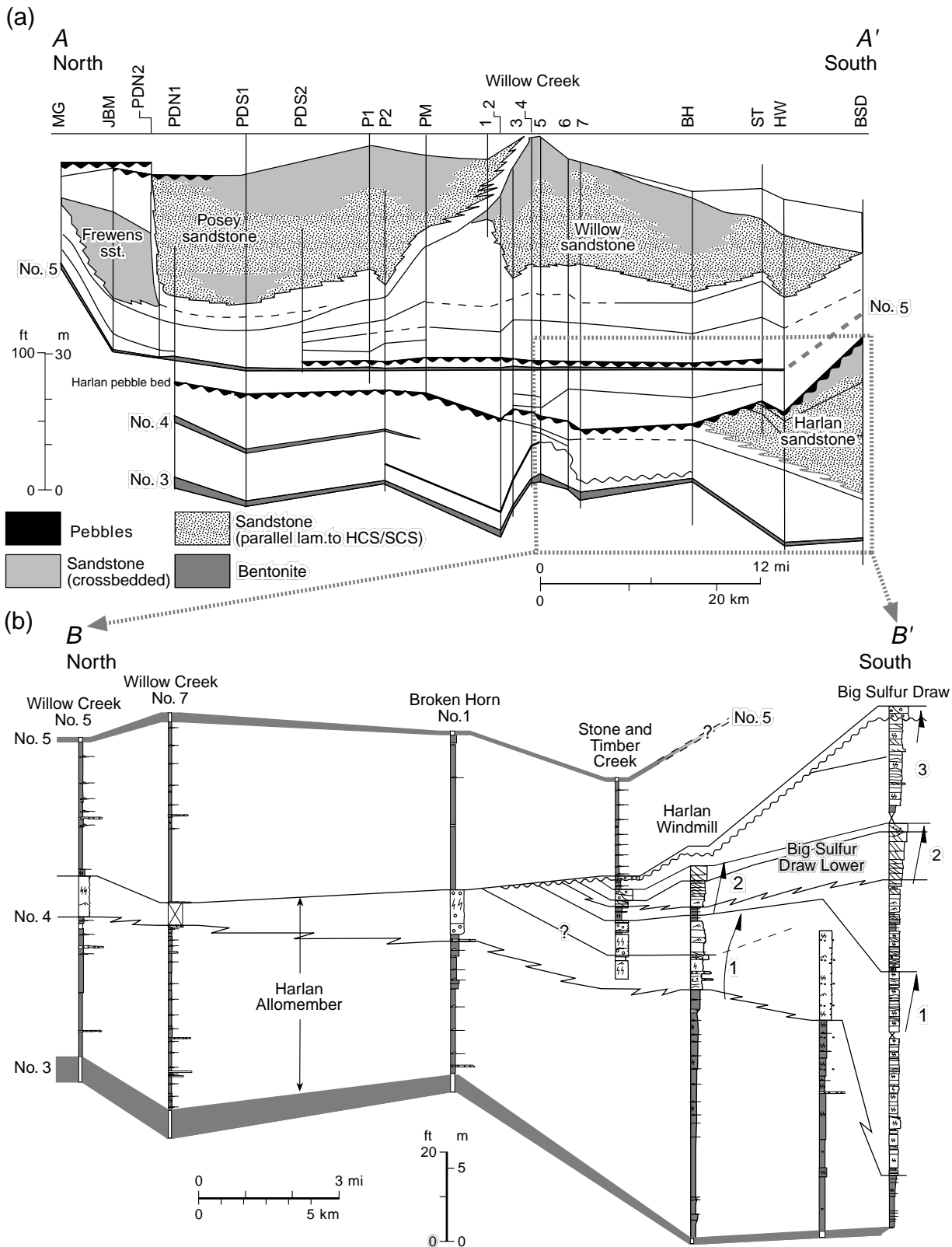

Figure 4. (a) Regional north-south outcrop cross section AA' oriented oblique to depositional strike showing correlation of Harlan, Willow, Frewens, and Posey allomembers. Note lateral stacking of sandstones. Variable datums used. Vertical lines represent measured sections. MG = Murphy Gulch; JBM = Jackrabbit Bentonite Mine; PDN = Peterson Draw North; PDS = Peterson Draw South; P = Posey Creek; PM = Posey Mine; W.Ck. = Willow Creek; BH = Broken Horn; ST = Stone and Timber Creek; HW = Harlan Windmill; BSD = Big Sulfur Draw. (b) Detail of cross section AA' through Harlan sandstones. Note erosion of succession 3 to the north. See text for discussion.

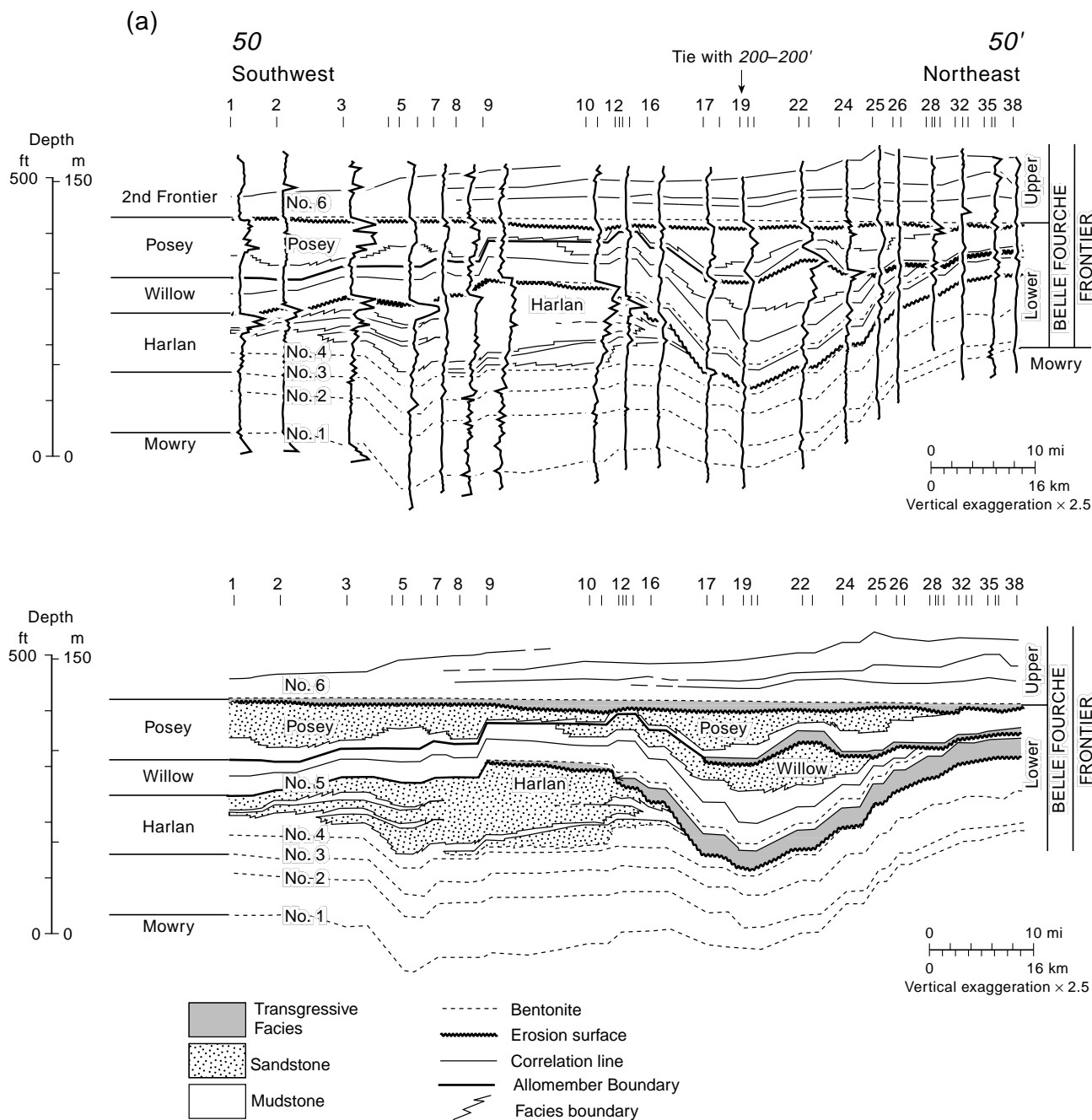

Figure 5. (a) Regional strike-oriented well log cross section. Willow sandstone fills trough adjacent to Harlan sandstone. Sandstones overlap along depositional strike, although thick areas are mutually evasive. Harlan sandstone appears to become shaly northeast of log 10. Note onlapping transgressive mudstones that overlie eroded lateral margin of Harlan sandstone to the northwest in wells 12–38. (b) (see next page) Regional dip well log cross section 200. Sandstones offlap and downlap to the southeast. All logs show resistivities. Cross sections are hung on the Thatcher biozone, and associated bentonite is above the Posey sandstone. Unnumbered wells were used in correlations but not illustrated. See Figure 1b for location and text for details. Continued on next page.

(b)

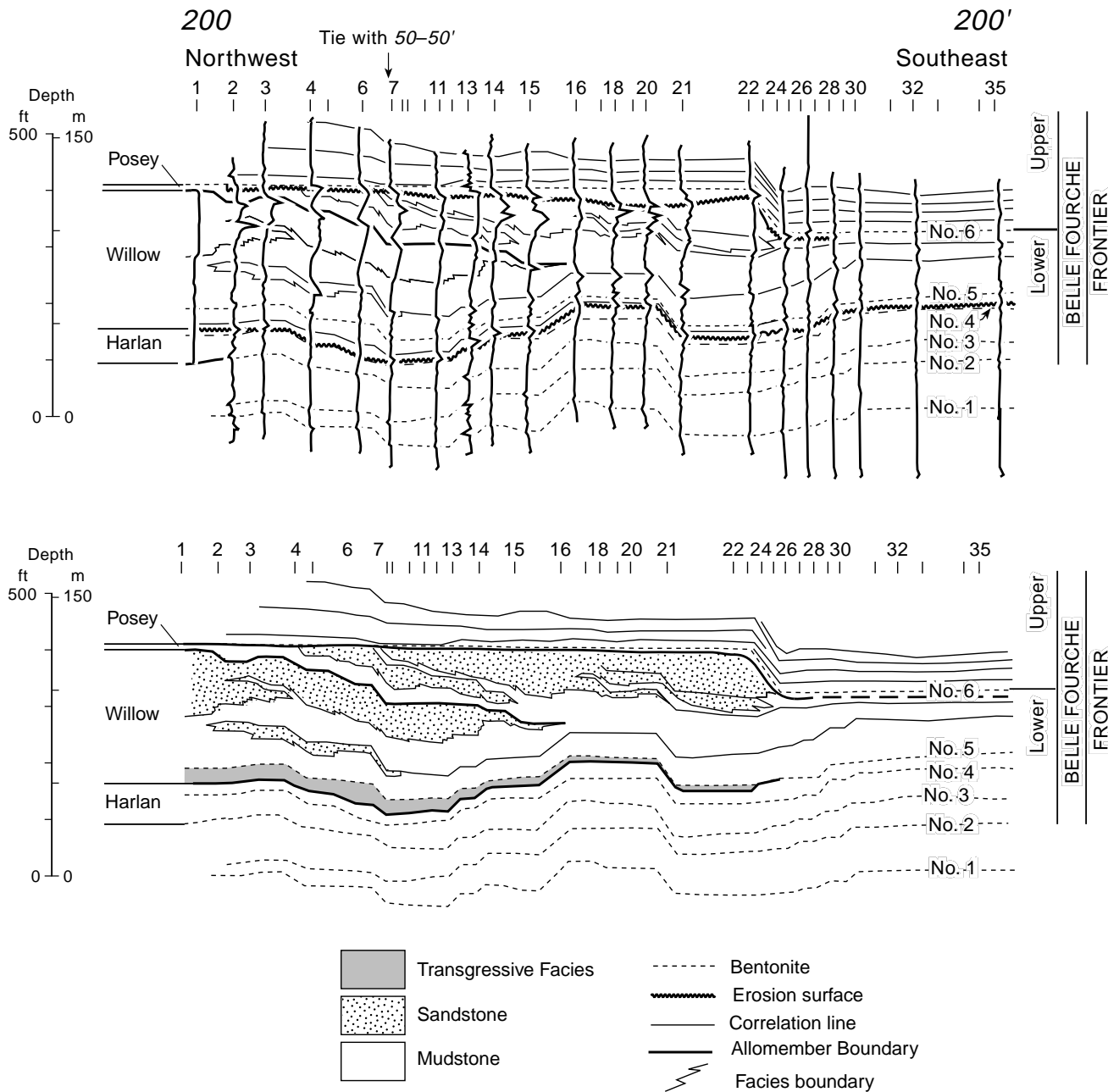

Figure 5. Continued.

which are each interpreted to record shoreface progradation and depositional shoaling. Beds within successions appear horizontal, except in a few locations where they can be seen to dip at a few degrees to the southeast (Figure 8a). The successions are dominated by very fine to fine-grained, hummocky, and swaley cross-stratified sandstones suggesting storm wave-influenced deposition (Figure 8b). Trace fossils define

a *Cruziana* to *Skolithos* ichnofacies, including *Planolites*, *Palaeophycos*, *Asterosoma*, *Skolithos*, *Arenicolites*, *Terebellina*, and uncommon *Ophiomorpha* and *Bergauaria* (Figures 7, 9). This assemblage indicates shallow marine shoreface conditions (Pemberton et al., 1992; MacEachern and Pemberton, 1992).

Angle-of-repose cross-stratified pebbly sandstones (Figure 8c) cap the uppermost succession. Although

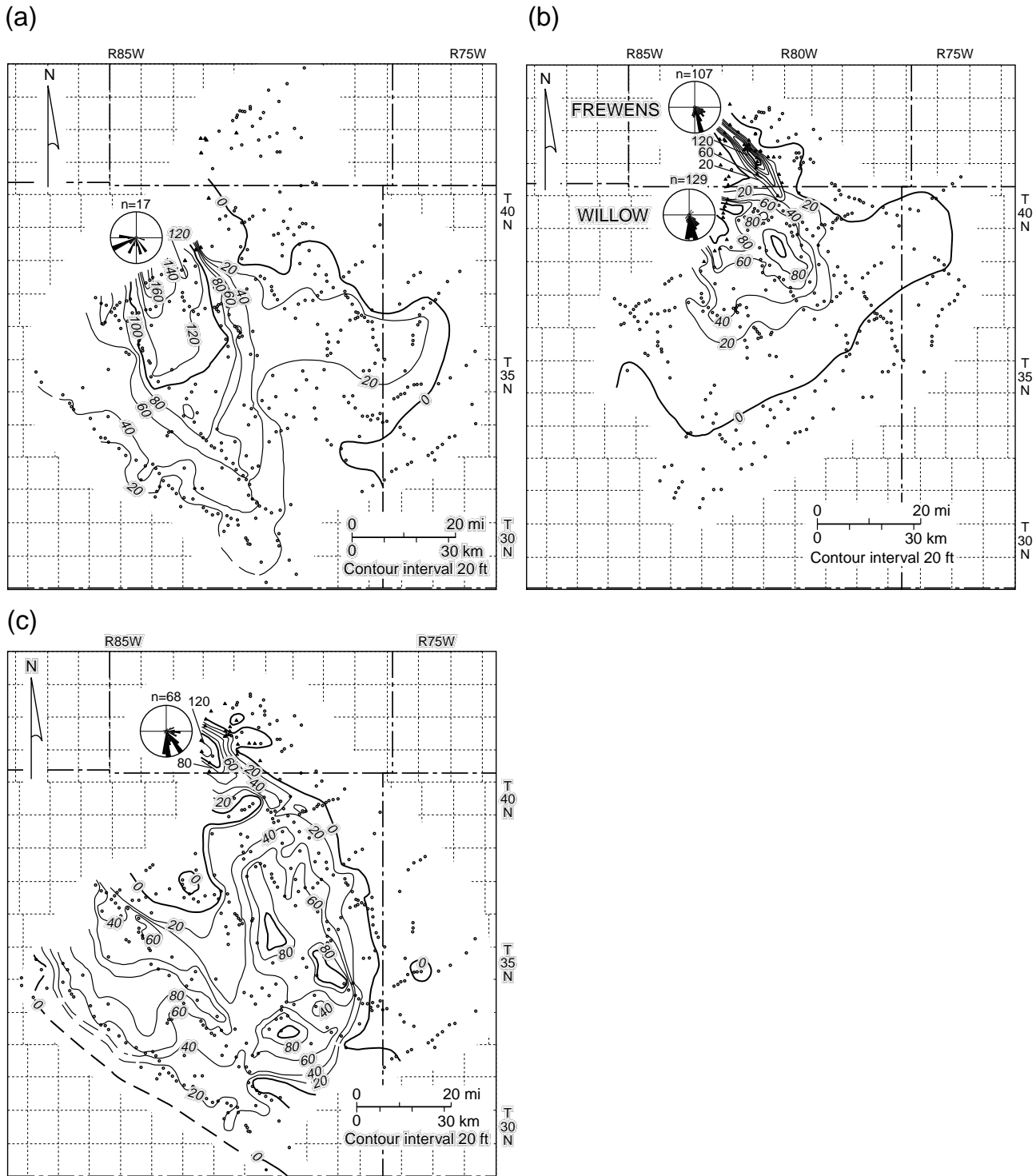
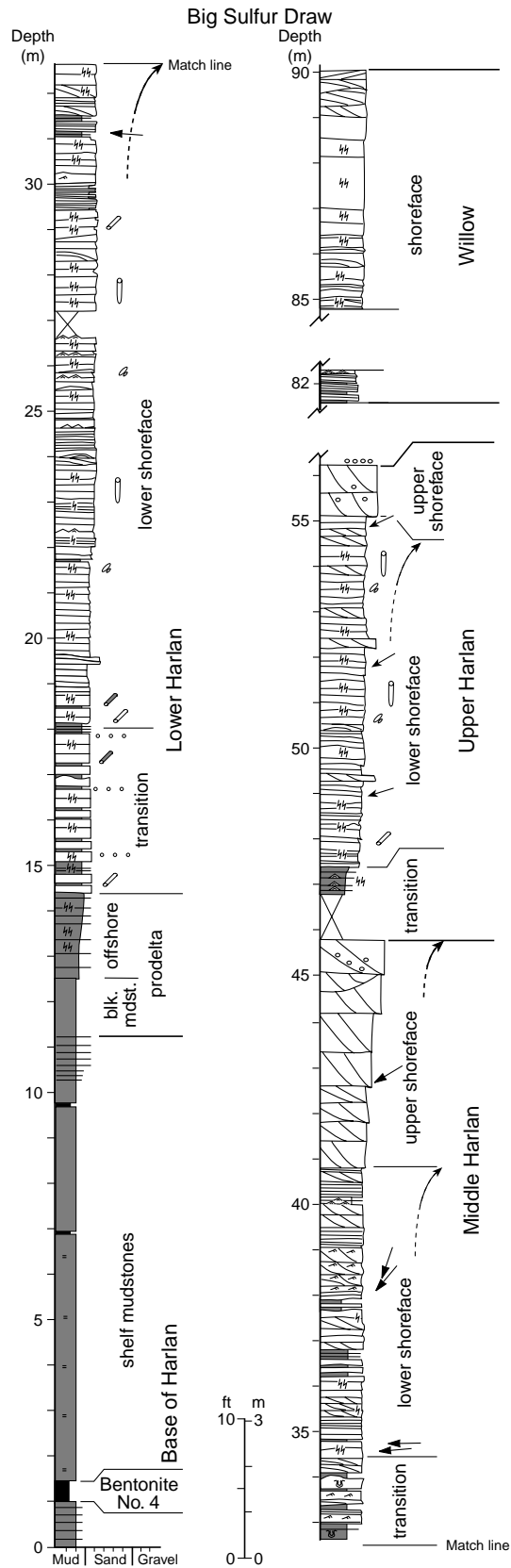

Figure 6. Sandstone isolith maps and regional paleocurrent rose diagrams for (a) Harlan allomember, (b) Willow and Frewens allomembers, and (c) Posey allomember. Note lobate sandstone geometries. Frewens sandstone is highly elongate and lies to the northeast of the Willow sandstone. The Harlan, Willow, and Frewens successively backstep, whereas the Posey represents a seaward shift in depocenters. Paleocurrents for all sandstones show flow predominantly between southeast to southwest, suggesting sediment was supplied from the northwest. Dots represent control points. Paleogeographic interpretations of these maps are presented in Figure 18.

(a)



(b)

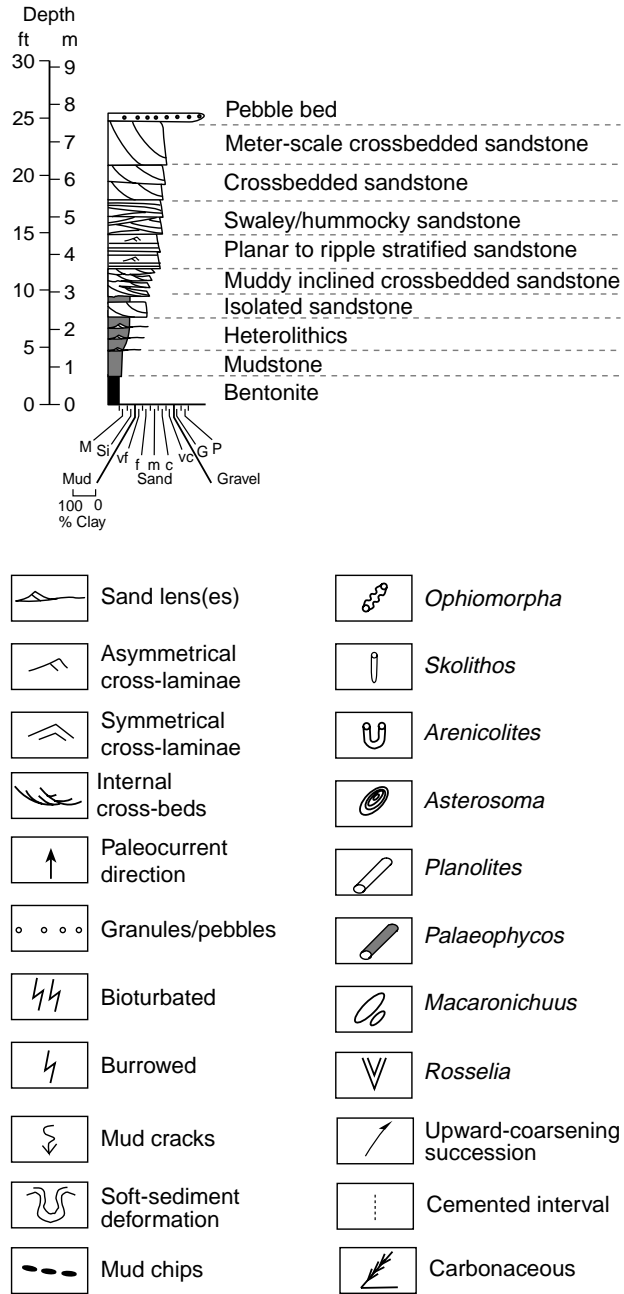

Figure 7. (a) Big Sulfur Draw type section through Harlan allomember. Location in Figures 1 and 4. Scale in meters. (b) Legend for all measured sections.

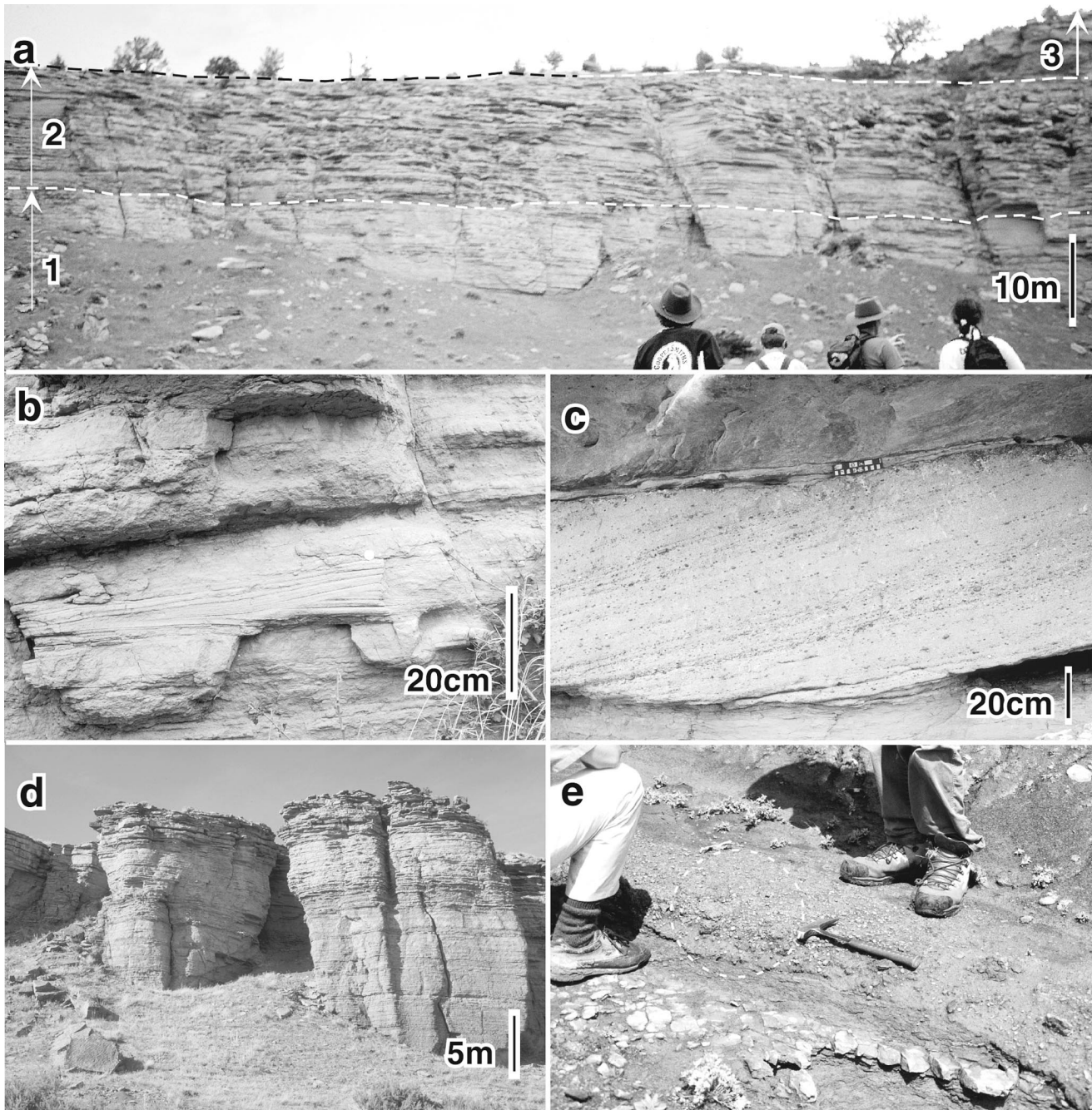

Figure 8. Photographs of Harlan allomember facies. (a) Low angle clinoform bedding in upward-coarsening cliff sections at Big Sulfur Draw (BSD) (Figure 4). (b) Hummocky to swaley cross-stratified sandstones. (c) Cross-stratified pebbly sandstones. (d) Upward-coarsening succession at Harlan Windmill (HW) (Figure 4). (e) Pebble bed encased in mudstones. This is the expression of the Harlan allomember as it is eroded to the north. (Location of photo on measured section is at 9 m in Figure 9.)

the contact between these coarse-grained cross-stratified and underlying hummocky/swaley sandstones is sharp, dominantly horizontal beds provide no evidence that these cross-stratified sandstones formed in channels. Paleocurrents measured from the cross-stratified sandstones radiate west to southeast and av-

erage 205° . To the north, the Harlan allomember is thinner (Figure 8d), and the pebbly cross-stratified sandstones and the upper two hummocky cross-stratified successions are cut out by a lag of chert pebbles, fish remains, and shark teeth (Figures 4b, 8e). Up to 25 m of erosion is indicated over the nearly 50

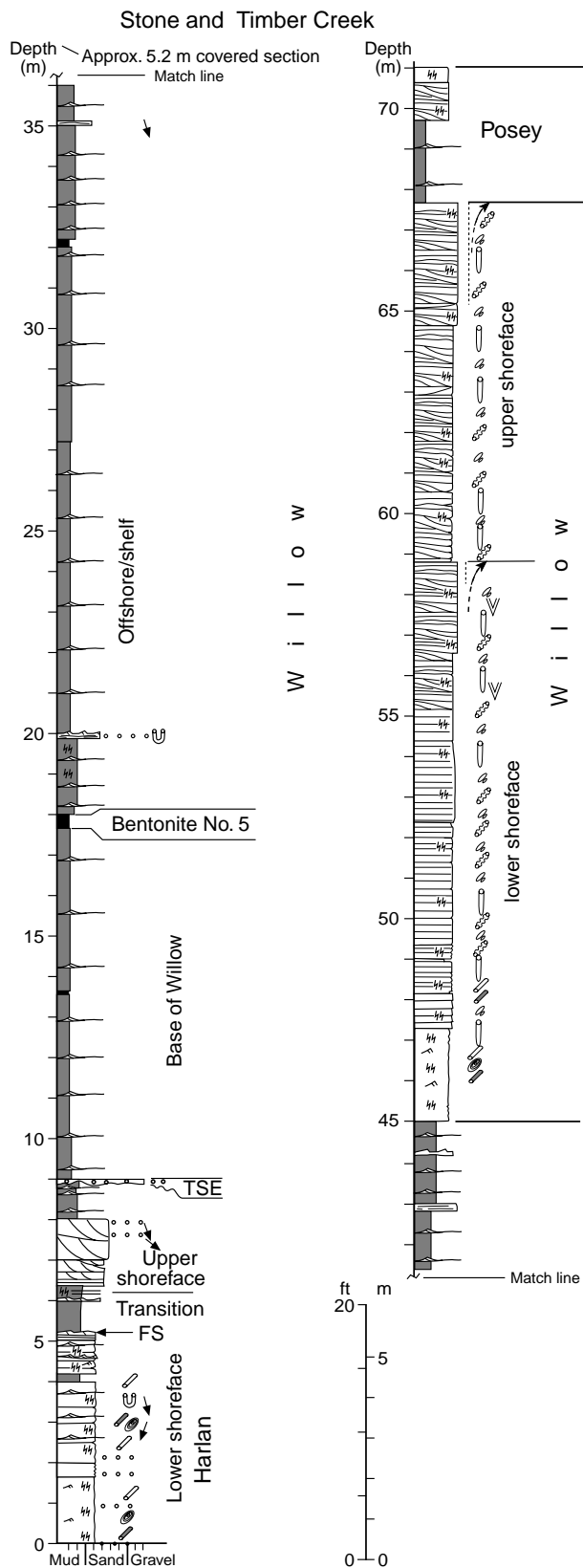

Figure 9. Measured section through Harlan and Willow allomembers at Stone and Timber Creek (ST). See location in Figures 1 and 4 and legend in Figure 7b.

km that this erosional lag can be traced across the outcrop belt (Figure 4b).

The three upward-coarsening successions can be correlated into the subsurface using well logs (Figure 5). The Harlan allomember grades into mudstone-dominated successions as it thins to the northeast, south and southwest. Thinning of the allomember is partially related to truncation by the capping erosion surface, particularly to the north. Bentonite 3 below this erosion surface converges to the northeast, and bentonite 5 is above this surface. This relationship suggests that, following Harlan deposition, subtle tectonic upwarping of the basin floor in the north end of the study area may have enhanced subsequent erosion of the top of these sandstones (Figures 4, 5a between wells 10 and 16). Locally, the allomember-capping erosion surface is overlapped by transgressive mudstones (e.g., between wells 10 and 17 on Figure 5a). These overlapping log markers are parallel to each other but show gentle undulation, lying stratigraphically lower, over sandstone-poor areas. Such undulations probably represent both subtle paleotopography and differential compaction. These markers, along with bentonites 4 and 5, are cut out farther east (i.e., in a more paleoseaward location) by an overlying erosion surface (Figure 5a, northeast of well 26).

Willow Allomember

The Willow allomember is named after exposures in cliffs above Willow Creek, where it is continuously exposed for more than 7 km (Figures 4a, 10a). Sandstones in the Willow comprise a broad lobe (Figure 6b). The sandstones are about 35 m thick in the center of the outcrop belt, and they gradually thin in both directions across the north-south outcrop belt to less than 5 m thick over a distance of 10–20 km. The sandstones initially widen to about 80 km as they thin into the basin and then narrow again as they grade into mudstones about 60 km into the basin. Paleocurrents determined from cross-strata are dominantly southeast (160°).

As in the Harlan allomember, Willow sandstones consist of amalgamated upward-coarsening facies successions interpreted to be prograding shoreface deposits (Figures 9, 11). In the subsurface, the upward-coarsening successions downlap to the southeast as they thin into mudstone (Figure 5b). In most areas, bedding within the sandstones appears horizontal; however, in some exposures, beds within successions

clearly dip at a few degrees to the southeast. An exposure cut obliquely across depositional strike, near the axis of the sandstones, shows beds in two stacked successions having apparent dips at very low angles to the north in the upper succession and to the south in the underlying one. This stacking of successions having oppositely dipping beds suggests these deposits represent different depositional lobes offset along strike (Figure 10c). Several areas of thicker sandstone are present, elongated northwest/southeast (5–10 km wide and a few tens of kilometers long, observed in the well log data Figure 6b). These areas of thicker sandstone probably reflect shoreline-normal elongate sandbars superimposed on the broader lobate Willow sandstones.

In the southern part of the outcrop belt, Willow sandstones are dominantly hummocky and swaley cross-stratified and have little angle-of-repose cross-stratification, indicating wave-dominated deposition (Figures 4a, 7, 9, 10b). Near the center of the outcrop belt, hummocky/swaley cross-strata dominates sandstones lower within the allomember, and angle-of-repose cross-stratified sandstones become progressively more common higher within the allomember (Figures 10d, e; 11). Although the low-angle and angle-of-repose cross-strata are dominantly ebb-dipping, numerous reactivation surfaces, alternating sets of sandier and muddier cross-strata, uncommon paired mud drapes, and locally abundant herringbone cross-stratification all suggest a strong tidal influence on deposition (Figures 10d, e). Evidence for a tidal influence on deposition generally increases to the north. Lower parts of Willow sandstones are moderately bioturbated by a shallow-water *Cruziana* ichnofacies consisting of *Palaeophycos*, *Planolites*, *Asterosoma*, *Bergaueria*, and thin mud-lined *Skolithos*. As successions coarsen upward, bioturbation changes to a shallow-water, high-energy *Skolithos* ichnofacies comprising *Macaronichnus*, *Skolithos*, and *Ophiomorpha* (Figure 10f).

The Willow allomember is capped by a thin erosional lag that becomes thicker to the northeast, where it contains scattered chert granules and chert pebbles. Evidence for stratal truncation below this lag is seen in subsurface correlations and suggests tectonic uplift to the northeast (Figure 5a, between wells 24 and 38). The distal end of Willow sandstones, exposed in the northern end of the outcrop belt, is a thin heterolithic unit capped by a decimeters-thick medium-grained sandstone bed a few meters above bentonite 5 (Figure 12b).

Frewens Allomember

The Frewens allomember is named for its exposures in Frewens Castle, a prominent butte adjacent to the East Fork of the Powder River on the TTT Ranch (see also Tillman and Merewether, 1994, 1998). Sandstones in the Frewens allomember have an elongate shape, about 5 km wide and at least 20 km long. The sandstones are divided into two upward-coarsening facies successions, each capped by a thin lag deposit and separated by thinly interbedded sandstones and mudstones, a few meters thick (Figures 12, 13, 14A). Although capping lags suggest that each succession could be assigned to different allomembers, they were combined here because it proved difficult to map them individually with the available data. Outcrop exposures cut the Frewens allomember at three locations along its length, and from these exposures, individual successions appear to be 2–3 km wide bodies that overlap along a southeasterly trend (Figures 6b, 12). Successions are about 35 m thick along their axis and gradually thin and become more heterolithic toward their margins (Figure 14A).

Beds exposed in cliffs oriented parallel to the axis of the sandstone dip as much as 15° to the southeast and show an offlapping geometry (Figure 14B). Beds exposed in kilometers-long strike outcrops dip at a few degrees in both directions away from the axis of successions toward their finer grained margins. The inclined beds are clearly truncated at the top of successions rather than asymptotic with the top of the sandstones (Figure 14B).

Lower parts of successions are lenticular- and flaser-bedded heterolithic facies (Figures 13 [e.g., between 29.4 and 44 m], 14C). Heterolithic cross-strata higher within successions are dominantly ebb dipping but show abundant evidence for tidal modulation of depositional currents, including rhythmic alternation of muddier and sandier cross-strata and reactivation surfaces having superimposed flood-oriented ripple cross lamination (Figure 14D). Successions culminate in meters-thick angle-of-repose cross-stratified medium and coarse-grained sandstones that have sparse granules, interpreted to be deposited on large ebb-dominated subtidal dunes (Willis et al., 1999). Mean paleocurrent directions are 132° for the upper sandstone and 160° for the lower sandstone. Unlike sandstones within the Willow and Harlan allomembers, bioturbation is practically nonexistent. Sparse *Planolites*, *Phycodes*, *Bergaueria*, and *Teichichnus* were noted, and marine

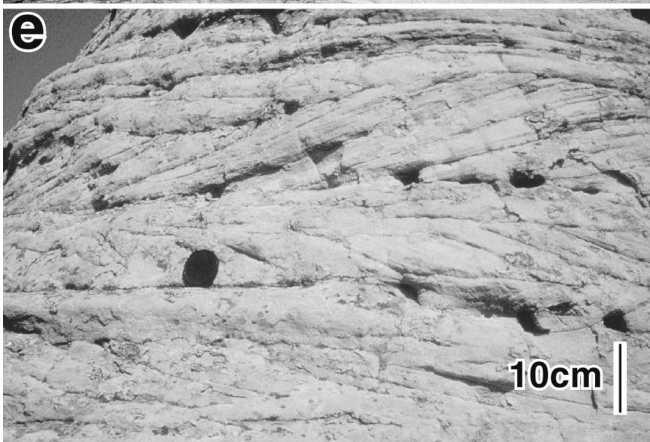
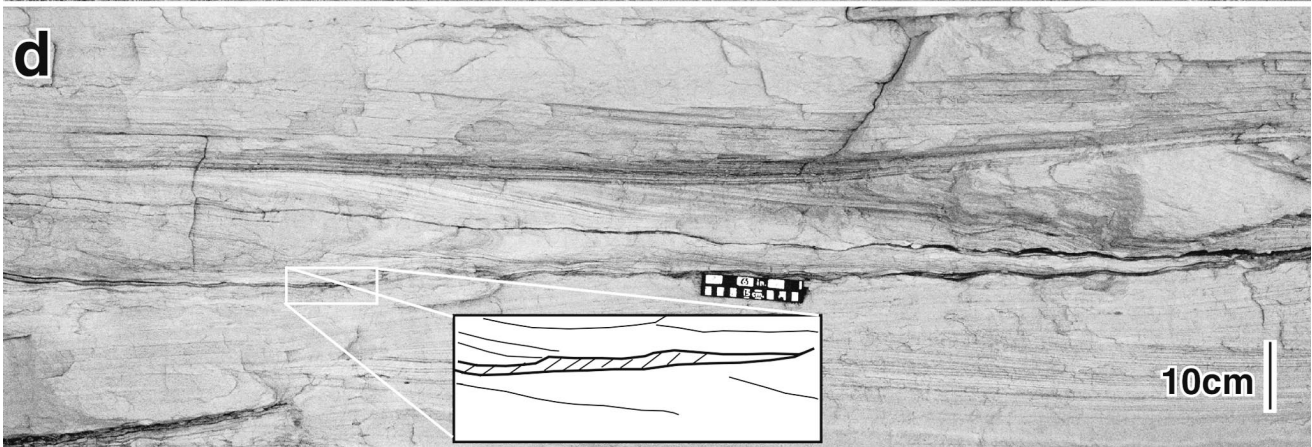

dinoflagellates indicate a connection with the sea (R. Curry, 1996, personal communication).

The Frewens allomember passes laterally over a few kilometers to the northeast of its sandy axis into two thinner, upward-coarsening mudstone-dominated successions, each capped by a pebbly sandstone bed (Figure 12). The capping lags are thicker and coarser grained there than where the sandstones are at their thickest. As the Frewens allomember thins to the northeast, the vertical transition from mudstone- to sandstone-dominated facies becomes progressively more abrupt (Figures 12; 15A, B). For example, 1 km north of Frewens Castle Butte (Section A, Figure 12a) the upper succession comprises 7 m of angle-of-repose cross-stratified sandstone in seemingly abrupt contact with underlying thin-bedded heterolithic facies. Although this facies contact at first view appears sharp, lateral tracing of beds showed that the sandy and heterolithic facies laterally intertongue (Figure 15B).

As the Frewens thins, the thickness of strata between bentonite 5 and the top of Frewens allomember also decreases from 50 m to about 25 m toward the northeast over a distance of about 4 km (Figure 12b, between sections C5 and W/N). In outcrop, the sandy top of Frewens allomember appears paleohorizontal over this distance because it parallels marker beds within overlying shales. Bentonites 4 and 5 and the intervening Harlan pebble bed below the Frewens allomember also remain parallel to each other but rise to the northeast relative to the flat top of the Frewens sandstones (Figures 12b; 15C). The uniform grain size and lateral persistence of the thick cross-stratified sandstones within the Frewens allomember suggests similar water depths and flow conditions across an area where the allomember decreases to half its thickness. These sedimentologic relationships, and the convergence of bentonites above and below the Frewens allomember, suggests mild tectonic folding prior to Frewens sandstone deposition. This folding is also associated with significant erosion of the underlying Harlan allomember, which is here expressed merely as a pebble lag (Figures 12, 15C).

Posey Allomember

The Posey allomember is named after cliff exposures above Posey Creek, where sandstones are about 37 m thick (Figures 16, 17). The sandstones are broadly lobate but show irregular thickness variations, particularly in the northwest and southwest (Figures 6c, 10c). In the outcrop belt, thick Posey sandstones are offset along strike relative to those in the Willow sandstone. At one location the finer grained lower interval of the Posey allomember is seen in a continuous cliff exposure to onlap the pebble lag that caps the thinning northern margin of sandstones in the underlying Willow allomember (Figure 10c). Posey sandstones extend for more than 100 km to the southeast, where they eventually pass into shales.

Similar to the underlying Willow allomember, Posey allomember sandstones consist of several upward-coarsening facies successions that offlap to the southeast (Figure 5b). Because of difficulties in mapping these individual successions, they were combined in a single plan view isolith map (Figure 6c). In some locations where the Posey allomember is thin, deposits comprise stacked laminated to thin-bedded facies successions that correlate with thicker sandstones elsewhere (e.g., Figure 12a). This pattern indicates depositional changes in allomember thickness along strike. In other locations Posey sandstone thickness variations appear to reflect irregular erosion at the top of the allomember.

Beds near the axis of the sandstone in the outcrop belt dip about 3° to 5° to the southeast (Figure 16). There, sandstones grade upward from poorly stratified burrowed very fine grained heterolithic sandstones, to planar laminated and low-angle cross-stratified (possibly swaley) sandstones, and finally to angle-of-repose cross-stratified medium-grained sandstone (Figure 17). Transitions between these vertically arranged facies are also observed down individual inclined beds, suggesting that they formed contemporaneously on a prograding shoreface. Paleocurrents are dominantly south and east (average 137°). Trace fossils change upward from a *Cruziana* into a high-energy *Skolithos* ichnofacies, the latter dominated by *Ophiomorpha*, *Macaronichnus*, and

Figure 10. Photographs of Willow allomember facies. (a) Upward-coarsening facies succession at Willow Creek. (b) Hummocky to swaley cross-stratified shoreface sandstones at Big Sulfur Draw (Figure 7a, 86 m). (c) Willow-Posey overlap at north Willow Creek (photo of Willow Creek sections 1, 2, and 3 in Figure 4a). (d) Tidal bundles at Willow Creek. Inset highlights double mud drapes in toe of cross-set separated by subordinate current rippled sandstone lens. (e) Bidirectional herringbone cross-stratification at Willow Creek (Figure 10, 62 m). (f) *Macaronichnus* burrows at Broken Horn (BH) (Figure 4a).

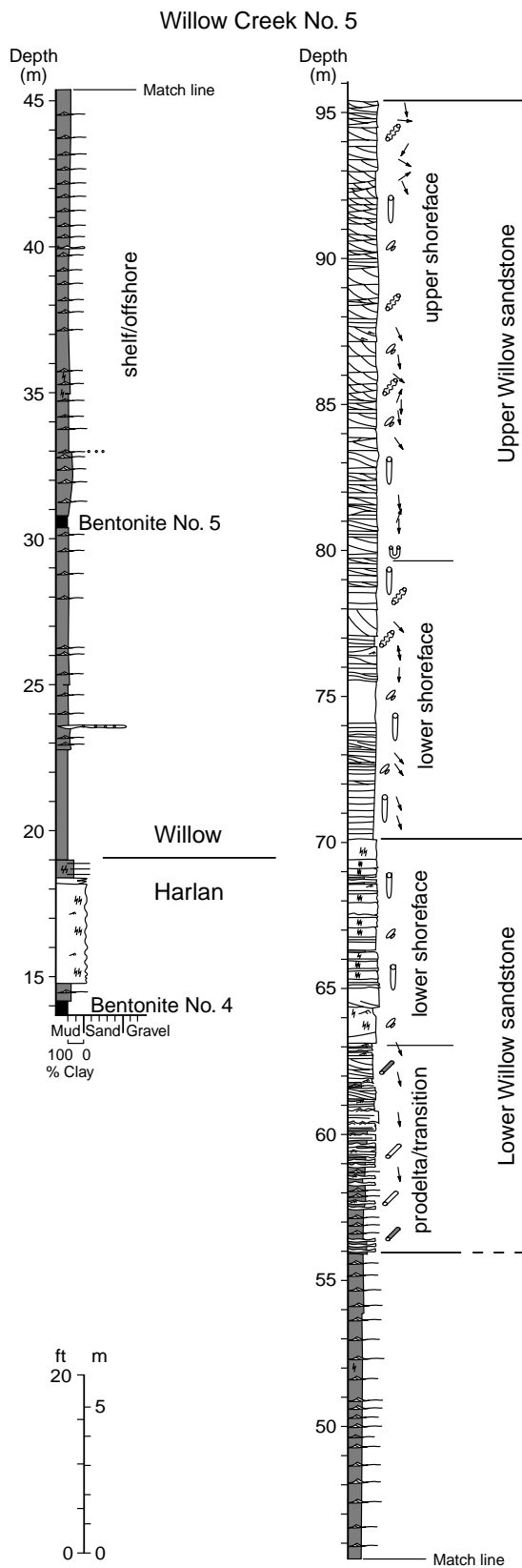

Figure 11. Willow Creek 5 is the type section for the Willow allomember. See location in Figures 1 and 4, and see Figure 7b for legend.

Palaeophycos. A pebble lag, up to 10 cm thick, caps the Posey sandstone regionally and truncates internal inclined bedding (Figures 4a, 5, 12).

In the northern part of the outcrop belt, the Posey is thin and heterolithic and contains a distinctive black, laminated mudstone reflecting onlap of relatively deep offshore shales (Figure 12). A cross-stratified, burrowed, pebbly sandstone erosively overlying this black mudstone marks the top of the Posey allomember at this position. Further into the basin, log markers defined by overlying bentonitic shales gently onlap the thinning southeast edge of the Posey allomember (Figure 5b, section 22).

DEPOSITIONAL INTERPRETATION OF ALLOMEMBERS

Deltaic Shorelines

The sedimentary structures, basinward inclined beds, and progressive upward increase in bed thickness and grain size within these sandstones are typical of deposits interpreted to have formed on prograding shorefaces and delta fronts (e.g., Clifton et al., 1971; McCubbin, 1982; Bhattacharya and Walker, 1992; Walker and Plint, 1992; Johnson and Baldwin, 1996). Trace-fossil and microfossil assemblages in the mudstones suggest stressed, brackish water environments rather than fully marine or distal shelf conditions. The lobate geometry of sandstones within allomembers, which thin and expand in areal extent basinward in the direction of radiating paleocurrents, suggest sediments fed by a point source rather than reworked along a coastline or dispersed across a shelf. The facies and geometry of these sandstones thus suggest that they are deposits of delta lobes fed by rivers (e.g., Coleman and Wright, 1975; Bhattacharya and Walker, 1992; Johnson and Baldwin, 1996). The paleocurrents and orientations of depositional lobes suggest that these rivers debouched into the northwest end of the study area and flowed to the southeast. Delta-front sands were reworked by a mixture of storm, wave, and tidal processes. The lack of evidence for subaerial exposure, presence of capping lags, and truncated inclined beds suggests that deltas were top truncated during transgression, rather than implying that these deposits were deposited far from the shoreline as offshore bars or shelf ridges.

The interpreted sequential paleogeographic history of allomembers within the lower Belle Fourche

(a)

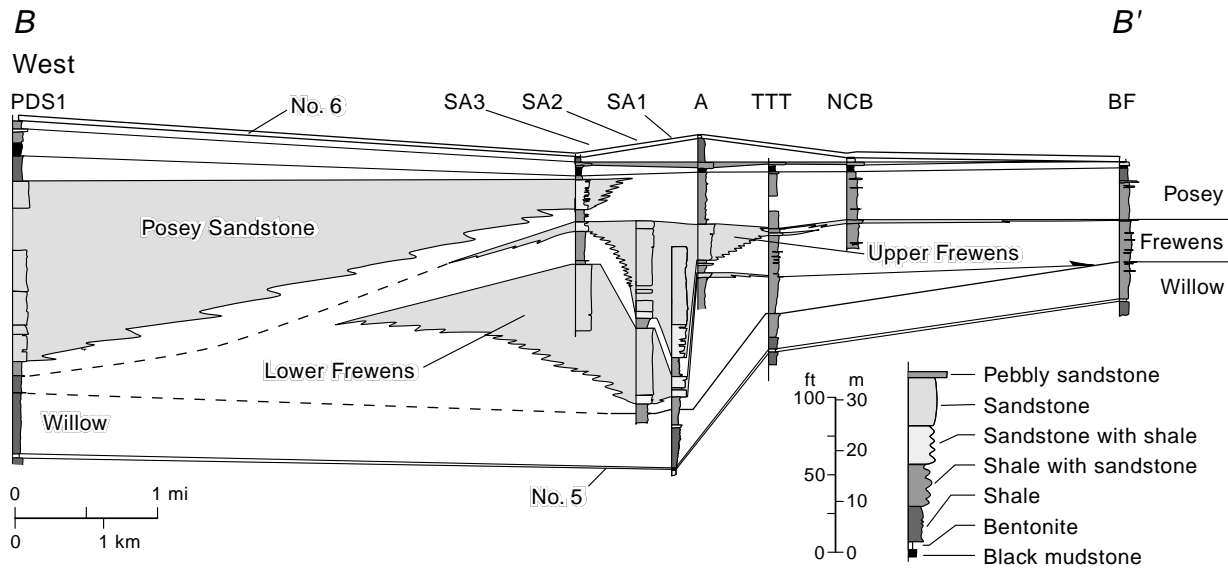

(b)

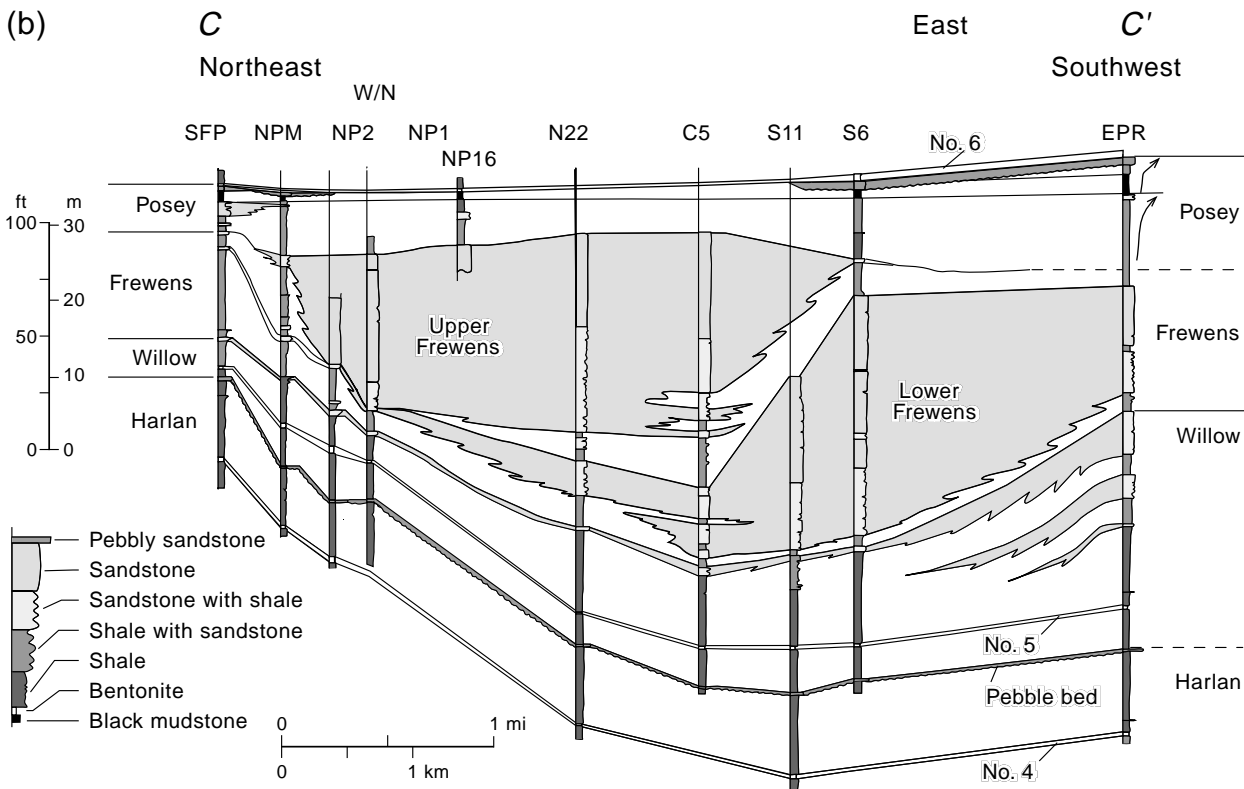

Figure 12. (a) Outcrop cross section BB' showing correlation of sandstones within Frewens allomember (location in Figures 1b, c). Frewens allomember contains two sandstones that lie under the Posey allomember. The sandstone isolith map (Figure 7b) shows that these sandstones are highly elongate. Frewens sandstones onlap the structurally uplifted mudstone equivalents of the Willow Creek sandstone to the northeast. PDS1 = Peterson Draw South #1; SA = South Amphitheatre; A = Amphitheatre; TTT = Three T Road south section; NLB = North Lone Bear Road section; BF = U.S. Geological Survey 1 Bailey Flats core. (b) Outcrop section CC'. Overlying black mudstone facies is assumed to be relatively flat and is used as the datum. Underlying bentonites appear to be folded. Frewens sandstones fill a structural low and onlap muddy facies of the Willow allomember. See location in Figure 1c. SFP = South Fork Powder River; NPM = North Perpendicular Mudstone section; NP = North Perpendicular Wall section; N = North Wall section; C = Castle; S = South Wall; EPR = East Powder River.

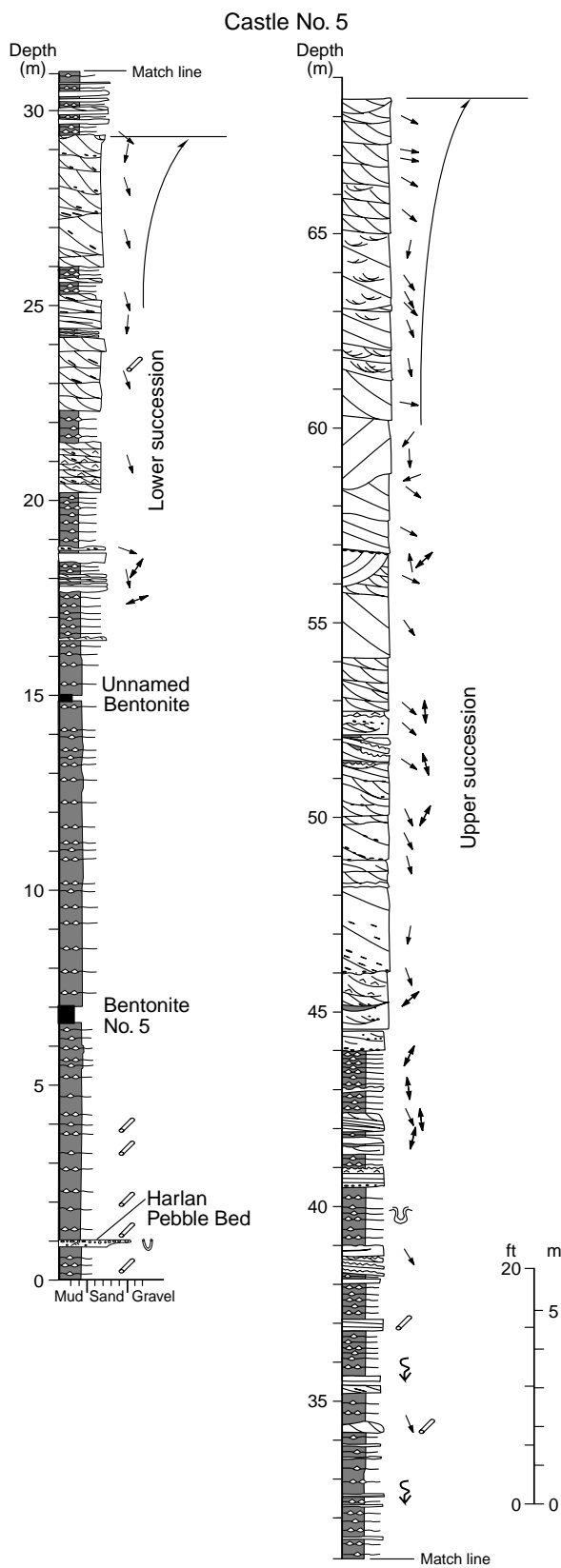

Figure 13. Frewens allomember, type section C5 at Frewens Castle. See Figures 12b and 1c for location, and see legend in Figure 7b.

Member is illustrated in Figure 18. The sandstones in the Harlan allomember extend significantly farther into the basin, have dominantly wave-formed sedimentary structures, and are more thoroughly bioturbated. The Harlan appears to have been deposited in an area more open to the basin. Sandstones in the Willow and Frewens allomembers progressively backstep relative to those in the Harlan allomember (Figure 18). Their internal sedimentary structures record progressively more tidally influenced deposition and a progressive decrease in bioturbation, suggesting a more brackish environment.

Many studies have suggested that tide-influenced deposits form preferentially during periods of sea level rise because rising sea level floods irregularities in coastlines to produce embayments that amplify tidal currents (e.g., summaries in Dalrymple [1992] and Reinson [1992]). In this case, the embayment appears to have been constrained by thick sandstones of the Harlan allomember to the south and a tectonic uplift to the north (see following discussion). Willow allomember sandstones, exposed in the outcrop belt, indicate more wave-influenced sandstones to the south and more tidally influenced sandstones to the north. A broad thin shoreline-parallel sandstone, seen in subsurface, skirts in front of the Willow sandstone and may represent a wave-reworked barrier sand along the front of this embayment. The elongate sandstone trends, shown by contours within the Willow isolith map (Figure 6b), are similar in geometry to sediment bodies on tide-influenced deltas (e.g., Bhattacharya and Walker, 1992; Dalrymple, 1992; Maguregui and Tyler, 1991). Willow deposition may have become more tidal as sediments progressively filled an embayment.

The elongate sandstone bodies that comprise the Frewens allomember are interpreted to be tidally reworked delta-front deposits. The internal architecture of these deposits is described in detail by Willis et al. (1999). Tide-influenced deposition left significantly more heterolithic and internally complex sandstones than the wave-dominated sandstones in the older allomembers. The lack of burrowing and the microfossils clearly show a strong river influence. The Frewens prograded into an elongate trough that comprised the northern end of the embayment initially filled by deposits of the Willow allomember.

The Posey sandstone indicates a major basinward shift in deposition, a return to wave-dominated deposition, and an opening of the seaway to the south that allowed the arrival of the Thatcher Fauna. Irregular truncation of the Posey allomember by its capping ero-

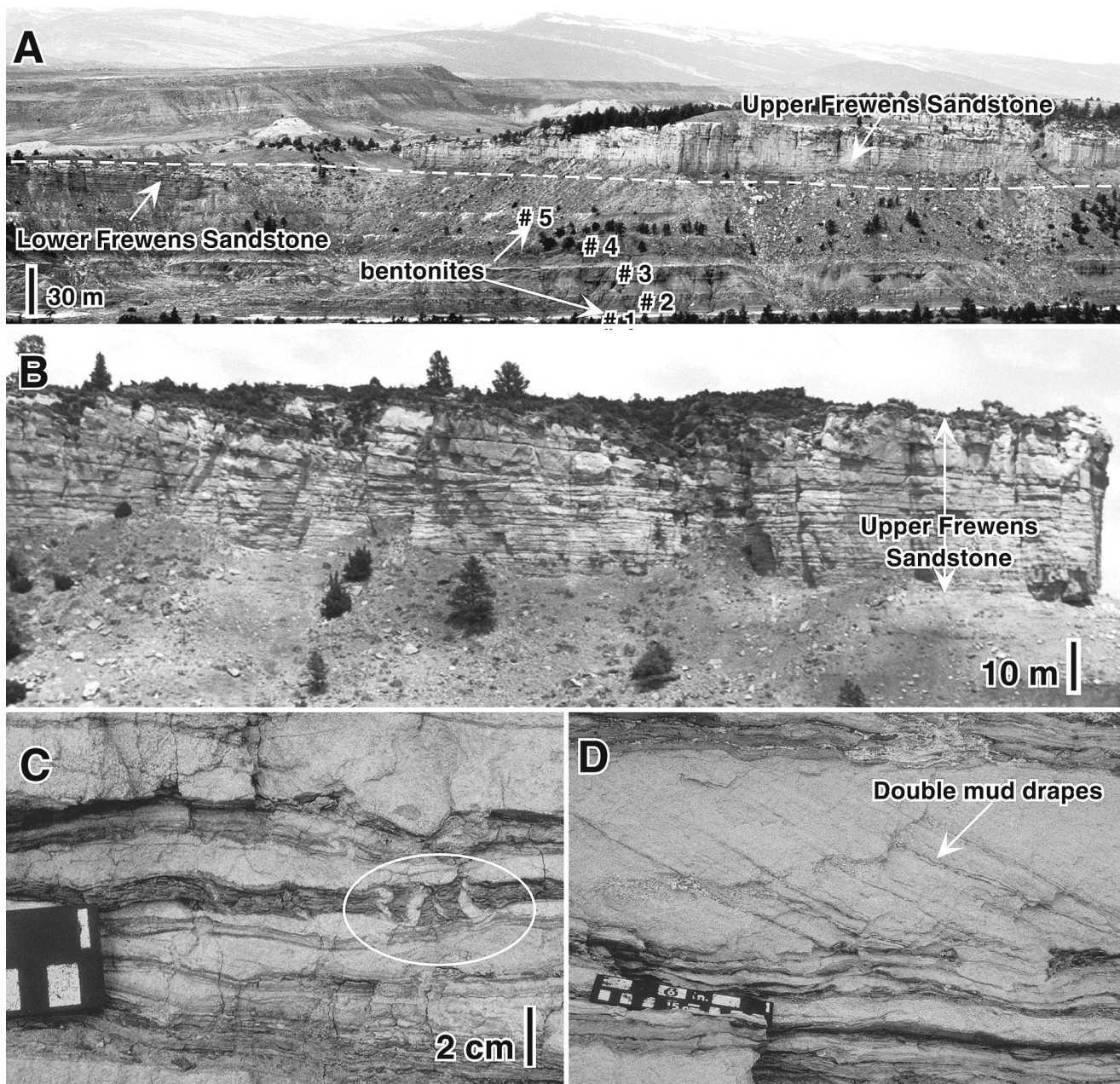

Figure 14. Photographs of Frewens allomember. (A) Overlapping sandstones of the Frewens allomember. View taken at the Tisdale anticline oil field looking west across Powder River. Note Bentonites in mudstones below cliffs. (B) Steep seaward inclined bedding parallel to paleoflow in north wall, near Frewens Castle at N22 (Figure 12b). Details of outcrop bedding architecture in Willis et al. (1999). (C) Subaqueous mud cracks in thin-bedded sandstones and mudstones at base of upper Frewens sandstone at Frewens Castle. (D) Double mud drapes indicative of tidal bundles near Frewens Castle.

sion surface probably reflects structural deformation associated with rejuvenation of sediment supply in the adjacent Sevier orogenic belt. Interpretation of the cause of this sediment influx would require a more regional study of the basin.

Comparison with Previous Interpretations

Past interpretations of these lower Belle Fourche sandstones based on a more limited set of outcrop logs suggested that (1) the Harlan sandstone is a wave- and

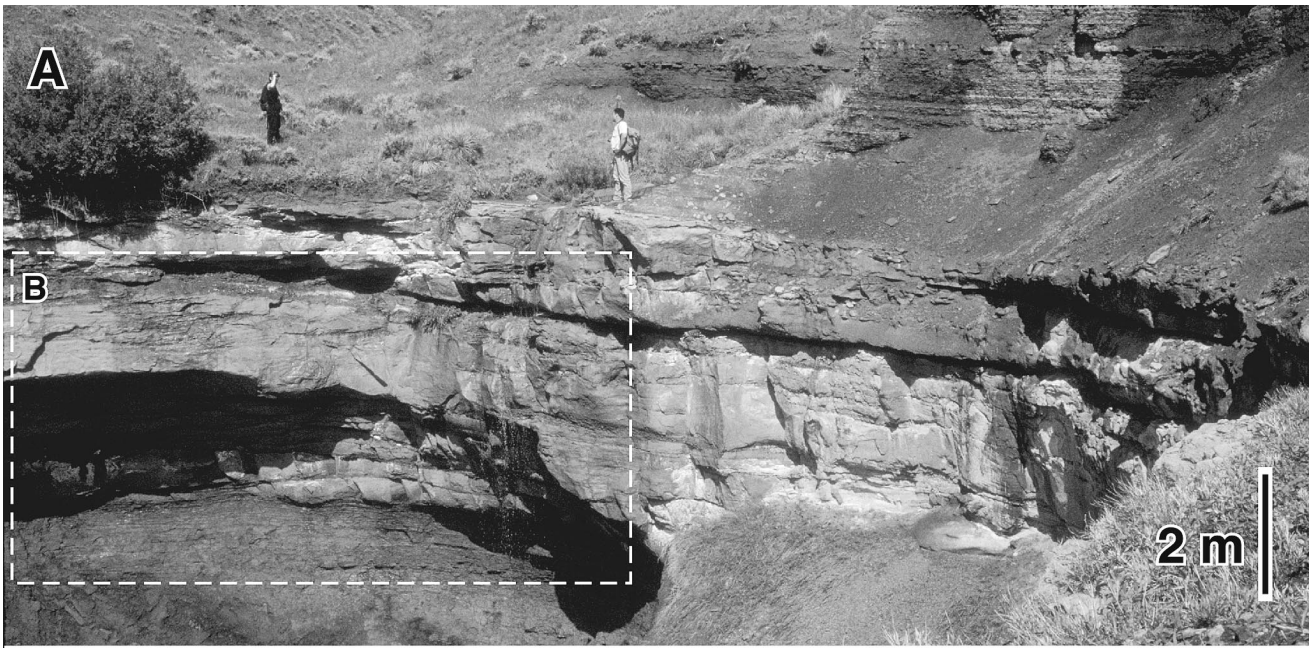

Figure 15. (A) Apparent sharp-base sandstone of Frewens allomember at Amphitheatre section (Figure 12a, section A). (B) Close-up of base showing interfingering. (C) Lateral pinch-out of Frewens sandstone about 1 km north of Frewens Castle (Figure 12b, sections NP2 to NPM).

tide-influenced shelf-ridge deposit and (2) the Willow and Posey sandstones were a continuous shoreface or shoreface-attached shelf-ridge sandstone cut by an estuarine valley fill that comprises the Frewens allomember (Tillman, 1994; Tillman and Merewether, 1994, 1998). Although these earlier studies helped us build our initial correlation framework, differences in the interpretation of some facies and a tracing of key surfaces within the outcrop belt led us to some different conclusions. We briefly address these differences in the following section.

Tillman and Merewether (1994) interpreted the Harlan sandstone (their Kf1 sandstone) to have formed as an offshore shelf ridge because it was originally described as (1) encased in marine shale, (2) showing a gradational contact with underlying shelf mudstones, (3) lacking evidence of subaerial exposure, and (4) lacking shallow-marine shoreface-type facies and trace fossils (e.g., *Asterosoma* and *Skolithos*). Paleoflows within the upward-coarsening facies successions suggested southeast progradation of a 40 m high bed form. They ascribed the upcurrent (northeast) pinch-out of this sandstone to erosion by normal marine currents on the stoss side of this large bed form. Because shoreface

profiles typically have only 10–20 m of relief, Tillman and Merewether suggested that it was unlikely that shoreface progradation generated the 40 m thick succession observed in the south end of the outcrop belt.

In support of a deltaic origin for the Harlan sandstone, we highlight (1) our documentation that the sandstone geometry is somewhat lobate and much larger than a typical shelf sand ridge (Figure 6a), (2) the radial orientation of paleocurrents parallel to the direction of sandstone body elongation, rather than highly oblique and unidirectional as expected for a shelf sandstone ridge (Huthnance, 1982), and (3) the occurrence of shallow-marine facies and trace fossils, including *Asterosoma* and *Skolithos*, typical of shoreface deposits. We showed that there are three stacked upward-coarsening successions within the Harlan sandstone, the upper two of which are locally top truncated by marine erosion surfaces (Figures 7, 9). Individual successions are less than 15 m thick and locally have internal inclined beds and facies consistent with that expected from progradation of a typical shoreface (e.g., McCubbin, 1982; Walker and Plint, 1992; Johnson and Baldwin, 1996). Although marine sandstone ridges can grow to heights of 40 m, they are typically



Figure 16. Inclined, top-truncated beds in upward-coarsening Posey allomember near Posey Creek (P1 in Figure 4a).

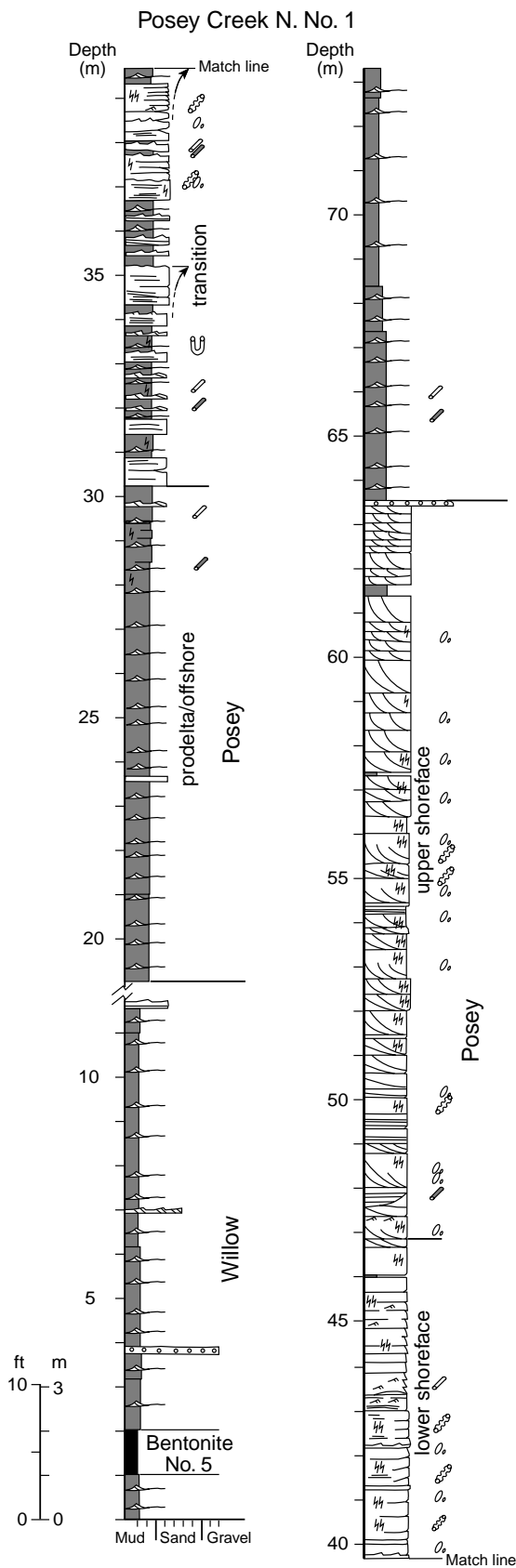

Figure 17. Posey allomember type section at Posey Creek (P1 in Figure 4a). Legend in Figure 7b.

only kilometers wide. Ridge sandstones are built in areas of sparse sediment supply during transgression and typically have an erosional base recording their migration over areas previous ravined by marine currents (Snedden and Dalrymple, 1999). Progradation of sandstones with gradational bases are more likely to form where sediment is being rapidly supplied to the basin, such as in a delta.

Tillman and Merewether's (1994, 1998) interpretation that the Frewens sandstones filled a fluviably incised valley was based on the abrupt lateral change in facies from highly bioturbated marine sandstones of the Willow allomember to nearly unbioturbated, very tidally influenced heterolithic sandstones of the Frewens allomember (lateral variations within their Kf2 sandstone). This rapid lateral facies change, between sections just a few kilometers apart, was interpreted to record the onlap of estuarine sandstones against the margin of a valley incised into more open marine deposits of a wave-dominated shoreface sandstone body. Large-scale cross-strata capping the Frewens allomember were interpreted initially to be of fluvial origin (Tillman and Merewether, 1994) and later as deposits of an estuary ebb-tidal mouth bar separated by a ravinement surface from underlying finer grained bay-head delta deposits (Tillman and Merewether, 1998). The base of the valley was inferred to be at a minor lag within the heterolithic deposits near the base of the sandstones exposed in Frewens Castle. A 10 m thick upward-coarsening succession of mudstones and heterolithic sandstones, capped by a thick pebble lag above the sandstones exposed in Frewens Castle, were interpreted to be the final fill of the valley with a capping ravinement surface.

Although we also think that the Frewens allomember filled a shoreline embayment, we disagree on the origin of the embayment and the interpretation of facies relationships within this embayment. We do not believe that the embayment formed as a consequence of cutting and then drowning of a fluviably incised valley. The heterolithic deposits beneath the minor lag deposits gradually thicken and become more sandstone rich to the south as they pass into the thicker deposits of the Willow allomember; we therefore ascribe this surface to minor ravinement following deposition of the deltaic lobes of the Willow allomember rather than to valley incision (Figure 12b). To the north, this lag parallels underlying bentonite beds, which indicates little erosion into underlying strata. The heterolithic deposits and the capping lag above the sandstones exposed in

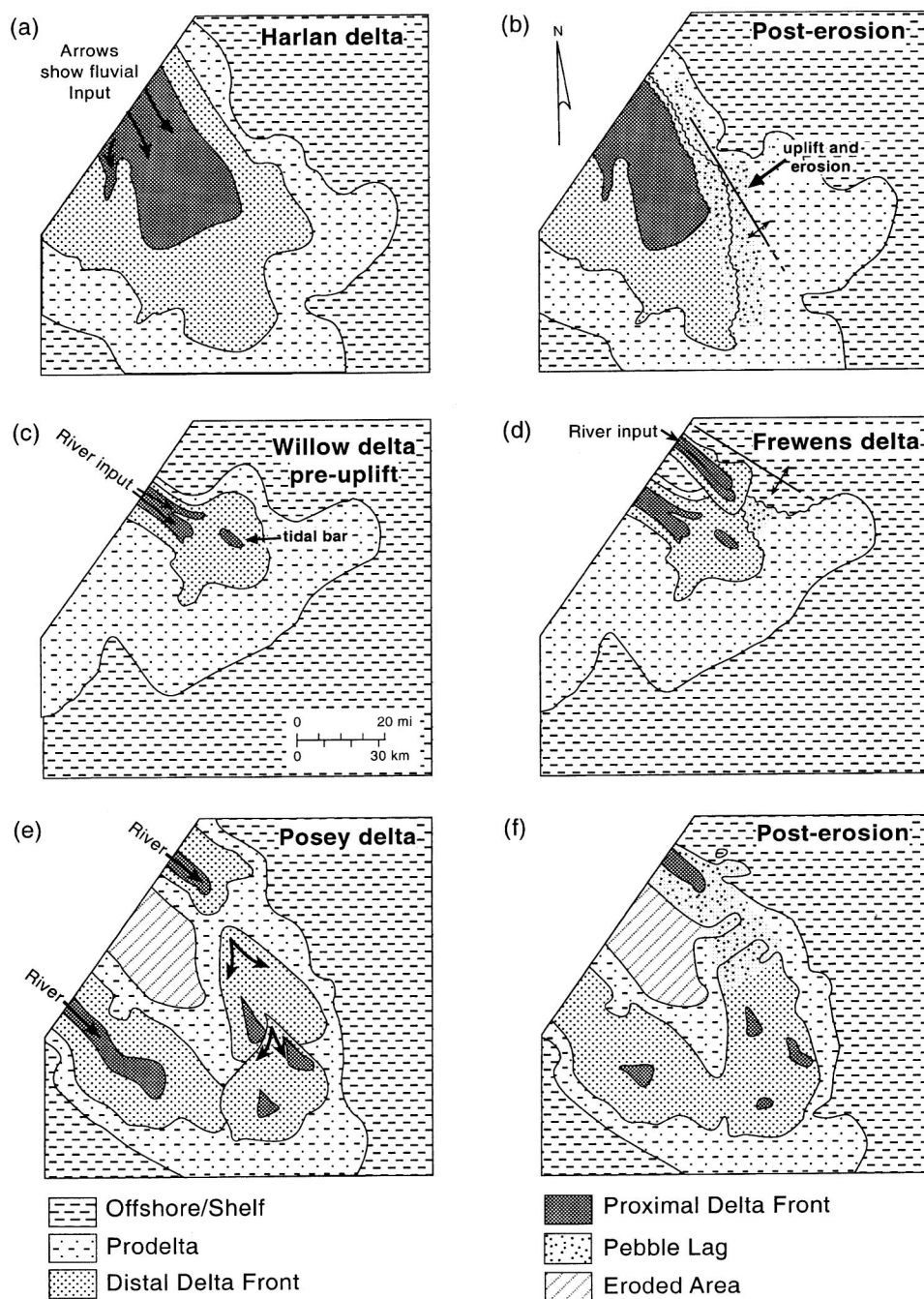

Figure 18. Paleogeographic history of interpreted deltas within the lower Belle Fourche. Paleogeographic maps are based on sand isolith maps (Figure 6) and interpretations of cross sections and facies presented previously. (a) Progradation of Harlan delta lobe. (b) Harlan is structurally uplifted to the northeast and is partially eroded. (c) Backstep and progradation of tide- and wave-influenced Willow delta lobe. (d) Some uplift of Willow lobe occurs to the northeast. An elongate trough is created, bounded by the less compacted sands of the Willow lobe to the southwest and a structural high to the northeast. The highly elongate tide-influenced Frewens delta fills this trough. (e) The Posey sandstones mark a major seaward step in the position of sandy lobes. (f) Final tectonic event uplifts parts of the Posey allomember, and it is partially truncated by marine erosion.

Frewens Castle gradually thicken and become sandier as they pass laterally into thicker deposits of the Posey allomember, which suggests they are the distal end of a younger deltaic deposit and its capping ravinement surface rather than part of a valley fill (Figure 12a). Although the upward coarsening from heterolithic to sandstone-dominated deposits is locally abrupt within individual successions of the Frewens

allomember, detailed tracing of beds exposed in depositional-dip-oriented outcrops showed that inclined beds within these successions pass laterally upward across this vertical facies transition. These inclined beds show that the entire upward-coarsening succession formed on a prograding bed form rather than on a bayhead delta erosionally capped by a transgressive estuary mouth bar (Willis et al., 1999).

SEQUENCE STRATIGRAPHY

Systems Tracts

These sandstones are the most distal shoreline-related deposits of lower Belle Fourche (i.e., middle Cenomanian) in the basin (see also Barlow and Haun, 1966; Merewether et al., 1979; Cobban et al., 1994), and they thus represent maximum regression of deltas into the lower Belle Fourche seaway, prior to the Thatcher transgression. We speculate that the fluvial valley complexes of the Frontier Formation, hundreds of kilometers to the west in the Green River basin region (Hamlin, 1996) fed sediment to the Powder River basin region. Tillman and Merewether (1998) observed sandstone-filled incised valleys below the Thatcher fauna in the Big Horn basin, which they suggested were the more closely related conduits of sediment to the lower Belle Fourche sandstones in the Powder River basin. The distal stratigraphic position of these delta systems documented here, and their reported association with incised valleys in more proximal parts of the basin, suggests that these deposits are all lowstand deltas within the context of the entire Frontier Formation.

Key Surfaces

Coarse-grained lags used to define boundaries between allomembers are regionally traceable and occur on surfaces having up to tens of meters of erosional relief over kilometers. These surfaces define the most important stratigraphic discontinuities within these deposits and mark genetic breaks in the facies trends that define potential reservoir and sealing units. These erosion surfaces, however, do not satisfy criteria commonly used to define sequence boundaries, *sensu stricto* Van Wagoner et al. (1990), such as basinward shifts in facies and evidence of subaerial exposure. Although some of our allomembers might have been subaerially exposed at one time, the evidence has been removed during transgression and thus subaerial exposure can not be determined unequivocally. Labeling these erosion surfaces sequence boundaries and defining the enclosed allomembers to be sequences might imply that the observed erosion associated with pebble lags reflects valley incision and consequent bypass of sandstone farther into the basin. We observed no evidence for significant volumes of sandstones bypassed basinward along these erosion surfaces in the most distal basin areas covered by our subsurface database. In contrast, these erosion surfaces are interpreted to have formed by transgres-

sive ravinement following maximum regression of the shoreline. Thus our allomembers are similar to the "transgressive-regressive sequences" of Embry (1993, 1995), as he also used transgressive ravinement surfaces as the main bounding discontinuity to define the major stratal units in distal-basin deposits.

The surface that should be designated a sequence boundary in basin-distal sandstones deposited during shoreline regression (Walker, 1990; Hunt and Tucker, 1992; Posamentier et al., 1992; Bhattacharya, 1993; Embry, 1995; Tesson et al., 2000) has been the subject of much debate. Kolla et al. (1995) and Tesson et al. (2000) defined the lowstand to include all sediments that prograded into the basin following the initiation of a sea level fall, even where they occur as a conformable succession above the underlying progradational highstand deposits. Hunt and Tucker (1992) defined the sequence boundary to be the surface marking the end of a sea level fall, and defined an underlying falling stage systems tract. Posamentier et al. (1992) suggested that shoreline progradation due to dropping sea level results in shoreface deposits having erosional bases produced by the abrupt downstepping of upper shoreface deposits onto more distal offshore shales. Evidence for such forced regression deposits has been widely reported for observations of shoreface successions interpreted to have formed during sea level fall (e.g., Bergman and Walker, 1988; Plint, 1988; Hunt and Tucker, 1992; Posamentier et al., 1992; Walker and Plint, 1992; Bhattacharya, 1993; Bergman, 1994; Bhattacharya and Posamentier, 1994; Nummedal and Moleenaar, 1995; Tesson et al., 2000). Helland-Hansen and Gjellberg (1994) suggested there was a complete gradation between gradationally based and sharp-based shoreface deposits controlled by the rate of sediment supply, the slope of the basin, and the rate of sea level fall (Figure 19). Thus they suggested that slow falls in sea level would leave behind gradationally based shoreface deposits, whereas rapid falls would produce sharp-based shoreface deposits.

Because deposition of sandstones and overlying shales studied here reflect dramatic changes in shoreline position within the basin, they record pronounced changes in sea level. The deltaic shoreface successions are all gradational with underlying shales. These sandstones formed near the terminal end of sandstone progradation into the basin and could have been deposited either during the last stages of gradual sea level fall or during the initial stages of a subsequent sea level rise (Helland-Hansen and Gjellberg, 1994). If deposited during the last stages of sea level fall, the deposits

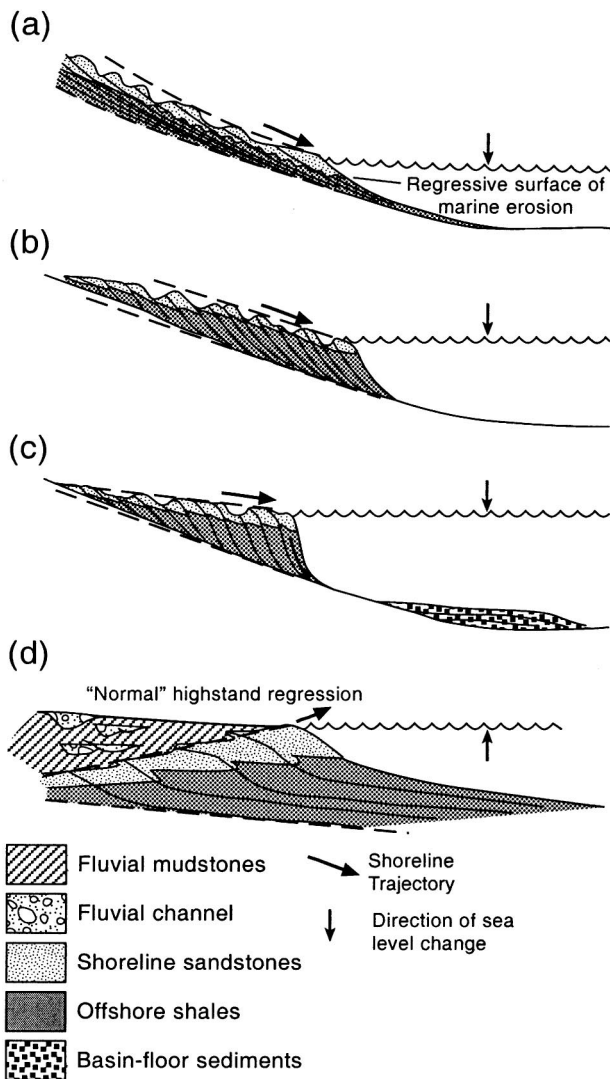

Figure 19. Examples of forced and normal regression (modified after Helland-Hansen and Gjellberg [1994]). (a) Sharp-based shoreline deposits are produced where the trajectory of a falling shoreline is greater than sea floor slope. (b, c) Gradational-based deposits, as observed in the lower Belle Fourche allomembers, are predicted where falling shoreline trajectory is equal to or less than sea floor slope. (c) Oversteepening can cause sediment gravity flows that are deposited on the basin floor. In all cases of forced regression (b, c, d), there is no subaerial accommodation, and delta topset facies are thin to absent. Thin topset facies may easily be reworked or eroded during subsequent transgression. These other examples contrast with (d) normal regression where shoreline trajectory is opposite of the basin slope. As a consequence, subaerial accommodation is positive, and significant accumulation of delta topset facies (i.e., fluvial channels, mudstones) can occur. Thick paralic and nonmarine facies thus accumulate and are more likely to be preserved.

would toplap against the base of younger valley fills in more landward areas of the basin. If deposited during the initial stages of sea level rise these deposits would ultimately onlap valley floors and margins. In the former case, ravinement lags at the top of allomembers may have removed fluvial deposits that correlated with the base of more landward positioned valley fills. In the latter case the base of a landward valley would pass seaward into a “correlative conformity” surface near the base of the prograding delta deposit. Maximum shoreline regression normally occurs after the initial onlap of sediments into the distal ends of valley fills, and thus any of the multiple internal progradational successions within these allomembers may have prograded during the transition of falling to rising sea level.

Although this study area spans 25,000 km², we could not document the relationship of these deltaic successions with surfaces in more landward positions of the basin. The key stratal relationships probably occur in strata lost during the Laramide uplift and more recent erosion of the Bighorn Mountains. We have adopted standard allostratigraphic nomenclature in this article based on the identification of mappable stratal discontinuities (NACSN, 1983) rather than a more trendy system of sequence stratigraphic terms because the latter would force us to assume a genetic relationship not demonstrated by our data. This article illustrates the difficulty in formally defining systems tracts and depositional sequences in distal-basin settings. Formal stratigraphic nomenclature must be flexible enough to allow for the logical subdivision and description of strata based on observable and mappable criteria, without first requiring interpretations based on hypothetical genetic models or missing evidence.

Preservation of Lowstand Deltas

Paralic facies formed on delta tops in low-accommodation settings have low-preservation potential because there is little space for them to accumulate during regression and they are susceptible to subsequent transgressive ravinement (Figure 19). Studies of modern deltas formed during falling sea level show significant truncation and reworking of topset facies, having only the more steeply dipping foreset and bottomset strata preserved (Corner et al., 1990; Hart and Long, 1996; Tesson et al., 2000). The amount of erosion documented to occur during shoreface transgression ranges from a few centimeters up to 40 m (e.g., Kraft et al., 1987; Nummedal and Swift, 1987; Trincardi and Field, 1991; Bhattacharya, 1993; Leckie, 1994)

and values in the Cretaceous Western Interior are estimated to average about 10–20 m (e.g., Bergman and Walker, 1988; Posamentier and Chamberlain, 1993; Walker, 1995). Thus transgressively modified discontinuities commonly remove evidence of subaerial exposure or paralic facies, leaving only a thin coarse transgressive lag facies capping distal shoreface deposits (e.g., Bergman and Walker, 1988; Larue, 1995; Valasek, 1995; Walker, 1995). If this lag is not recognized, then these sandstones may be erroneously interpreted as entirely offshore in origin and not as top-truncated deltas.

Given evidence for substantial erosion during ravinement, criteria for recognizing ancient deltas needs to be reevaluated. Critical to the original definition of delta deposits (Barrell, 1912; Alexander, 1989) was that a proportion of deltaic deposition occurs above water, forming topset deposits. Although topset facies have low-preservation potential in low-accommodation settings, the preserved foreset deposits nevertheless record deltaic processes influenced by the balance of river, wave, and tidal currents during shoreline regression. This influence can be recognized by detailed analysis of facies, trace fossils, body fossils, and sedimentary structures.

Syn depositional Deformation of the Basin Floor

Relationships between bentonite beds and erosional lags clearly demonstrate that there was syn depositional deformation of the basin floor during Frontier deposition. Continuation of prominent sandstone-capping lags into shale-dominated successions to the northeast indicates that the lobate Harlan and Willow sandstones were preferentially eroded along their northern edge. The convergence of some bentonite beds, and not others, to the northeast, in the direction that the sandstones asymmetrically thin, suggests that this enhanced erosion occurred because of the episodic syn depositional tectonic uplift of a topographic high in the northern end of the study area (Figures 5a; 18b, d, f). Although the slopes associated with this tectonic folding are too subtle to see directly in the outcrop ($<<1^\circ$), basin-floor topography produced by this folding was equivalent to that produced by the prograding sediments. Deformation appears to have effected both sandstone body placement and subsequent patterns of erosion.

Several other studies have concluded that there was syntectonic control on paleogeography and deposition of reservoir sandstones within the North Amer-

ican Cretaceous foreland basins during lowstands (e.g., Nummedal and Riley, 1991; Plint et al., 1993; Jenette and Jones, 1995; Larue, 1995; Van Wagoner, 1995; Taylor and Lovell, 1995). Such folding probably reflects reactivation of previous crustal weaknesses during varying loading or in-plane stresses generated far to the west in the evolving orogenic belt (e.g., Cloetingh, 1988; Heller et al., 1993; Donaldson et al., 1998). Complex interaction of uplift and marine erosion can result in smaller preserved erosional remnants of originally larger sand bodies (e.g., Martinsen and Krystinik, 1998). Where accommodation is at a minimum, subtle basin floor topography exerts a much stronger control on the position of sand bodies, particularly near the peripheral bulge (e.g., Heller et al., 1993). Some investigators have interpreted discontinuities, similar to those capping allomembers in this study area, to have formed by fluvial erosion and subsequent ravinement, despite a lack of diagnostic fluvial deposits or evidence of subaerial exposure (Larue, 1995; Sullivan et al., 1997). An increasing number of studies have documented the importance of marine erosion over flexural uplifts in distal foreland basin settings where subaerial exposure and fluvial incision are unlikely to have occurred (e.g., Bergman and Walker, 1988; Hart and Plint, 1990; Walker, 1995; Donaldson et al., 1998; Martinsen and Krystinik, 1998).

EXPLORATION AND PRODUCTION SIGNIFICANCE

Few other studies have interpreted distal-basin sandstones as the deposits of deltas, despite the fact that rivers are the obvious way to deliver sand to distal-basin areas during lowstands. The idea that both broader lobate sandstones and narrower more elongate sandstones documented by this study formed during delta progradation has different implications for both the exploration and production of these sandstones than do models suggesting other depositional environments. Implications of interpreting these sandstones as delta deposits are briefly discussed in the following section.

The internal geometry of beds within a sandstone body can impact volume predictions and the recovery of hydrocarbons. Recent studies modeled effects of dipping delta-front sandstones and interbedded shales on fluid-flow recovery and demonstrated that earlier layer-cake lithologic correlation schemes failed to represent stratal architecture controls on reservoir behav-

ior (e.g., Ainsworth et al., 1999; Tye et al., 1999). These studies emphasized that knowledge of both the magnitude and direction of bed dips is critical to effective reservoir management.

Deposits of offshore bars, wave-dominated shorefaces, and deltas are predicted to have different bed-dip angles and directions and degrees of bed heterogeneity. Beds within offshore bar deposits may dip either landward or seaward but are generally oriented perpendicular or slightly oblique to the elongation of sandstone (e.g., Berné et al., 1991; Shurr, 1984). Coarser grained, better-quality reservoir facies typically lie on the upcurrent margin of the sandstone. Beds in shoreface deposits dip seaward, perpendicular to the elongation of the sandstone body. Grain size decreases basinward, and it typically increases updift toward the source of sediment input to the coast. Because sediment feeder systems may be dispersed at various points along a coastline, and longshore drift directions may vary along the coast, lateral changes in reservoir quality along the length of shoreface sandstones may be hard to predict. Beds in delta-front deposits also dip seaward, but in contrast to wave-dominated shorefaces, they tend to be parallel to the direction of sandstone body elongation and they may radiate basinward (Willis et al., 1999). Because sediment always enters deltas at their landward end, facies variations related to basinward decreases in depositional currents and sedimentation rate produce predictable changes in reservoir quality within mapped lobes. Beds in river- and tide-influenced delta deposits tend to be more heterolithic than those in shoreface and offshore bar deposits. Because offshore-bar sands and shoreface sands tend to be significantly reworked during transport across the shelf or by longshore currents, respectively, they tend to have few long interbedded mudstones. In contrast, rivers entering deltas typically carry 85 to 95% mud, and this mud becomes trapped in the delta-front environment unless there is significant wave energy to winnow and transport the mud farther basinward (Bhattacharya and Walker, 1992). Tides can be particularly effective in trapping mud in the delta front (Dalrymple, 1992; Willis et al., 1999), and tide-influenced deltas thus make particularly heterolithic reservoirs.

Distinguishing shore-parallel elongate shoreface sandstones from the more heterolithic, shore-normal elongate tide-influenced deltas can be problematic in subsurface examples where core data are not available. Because both types of deposits can be left as isolated, upward-coarsening sandstone bodies during shoreline

transgression, they may appear similar in standard well logs unless there is enough well control to demonstrate lateral facies changes. Production data or detailed dipmeter logs might help define the internal stratal architecture. Microfossil data from cuttings might also indicate whether the depositional system was brackish or more open marine. In reservoirs where core data are available, the fluvial influence can commonly be identified by examining ichnofacies and fossils of interbedded delta-front and prodelta muds (e.g. Moslow and Pemberton, 1988; Bhattacharya and Walker, 1992; Gingras et al., 1998; and this article).

Different genetic interpretations of elongate sandstones can also strongly influence regional stratigraphic and paleogeographic models used to guide exploration. If the northwest-southeast elongate sandstones documented in this study were shore-parallel shoreface deposits, then seaward would be to the northeast and landward would be to the southwest. In contrast, if these were elongate delta deposits, then land would be to the northwest. Exploration geologists assuming a shoreface origin for this elongate sandstone might predict valley feeder systems to the southwest and search for along-strike shoreface sands to the southeast. They would interpret the western pinch-out of sandstones as a landward pinch-out rather than the lateral fringe of a delta lobe.

In low-accommodation settings, larger scale stacking patterns of deltas can be difficult to interpret using conventional sequence stratigraphic techniques that emphasize vertical stacking patterns in individual well logs or cross sections (e.g., Van Wagoner et al., 1990). Our study shows that sandstones at apparently similar stratigraphic levels belong to different age delta lobes separated by relatively thin mudstone layers. Areas of overlap between adjacent lobes are only a few hundred meters to a few kilometers wide and thus might be easily missed in widely spaced subsurface data sets. Missing these divisions could result in an overestimation of reservoir continuity, a greater difficulty in defining rock property trends, and missed opportunities related to laterally sealing shales.

Although stacking patterns may be difficult to document in a single well or cross section, the map-view arrangement of sandstone bodies can provide important information about the potential quality of reservoir compartments. For example, in this study, delta lobes in strongly seaward-stepping allomembers (Harlan and Posey) are broader, were more wave influenced, and formed relatively homogenous and potentially interconnected reservoir compartments. In

contrast, delta lobes in the backstepping allomembers (Willow, Frewens) are typically more elongate, were more tide- and river-influenced, and formed more heterolithic and potentially less connected reservoir compartments. Individual delta lobes would be significant reservoirs with predictable internal properties. For example, one sandstone in the Frewens allomember (2 km × 20 km, 10 m pay thickness, 15% porosity, and 20% water saturation) could hold upward of 250 million bbl of oil. Delta lobes in the other allomembers are even larger and they have a better chance of being interconnected.

Evidence that sandstones are confined to the flanks of subtle structures, rather than being randomly distributed as a consequence of autocyclic delta switching, can also change exploration strategies. Subtle tectonics creates lows that are attractive sites for deltaic deposition, and syndepositional uplifted areas are sites where enhanced erosion can isolate parts of previously deposited sandstones. If these subtle uplifts occur in predictable locations over preexisting zones of crustal weakness, lineaments, or other structural features, then structural mapping, rather than only sequence stratigraphic concepts, should be the focus of exploration models. Many basin-distal, elongate sandstones may be depositional remnants of once much larger prograding delta systems preserved within structurally enhanced lows (Martinsen and Krystinik, 1998) rather than incised valley fills (Sullivan et al., 1995; Tillman and Merewether, 1998) or other types of depositionally delineated marine sand bodies. Although the distinction between a sand-filled valley incised into shelfal shales and a delta sand built into a structural low seems obvious, in practice the same deposits have been interpreted in radically different ways (e.g., articles in Bergman and Snedden, 1999). Interpretations vary depending on which datums are used to align well logs and which depositional, sequence stratigraphic, and structural models are used to support the correlation of key stratigraphic surfaces. In this study area we were fortunate to have well-exposed, laterally continuous outcrops and multiple bentonite horizons that could be used to constrain the well log correlations. Without these advantages, interpretation of these distal-basin sandstones may have been more ambiguous.

CONCLUSIONS

1. Regional correlation of isochronous bentonites and ravinement surfaces were used as bounding discon-

tinuities to define and map four allomembers within the lower Belle Fourche Member of the Frontier Formation. From oldest to youngest, these are the Harlan, Willow, Frewens, and Posey allomembers.

2. Lobate to elongate geometries, upward-coarsening facies successions, basinward-dipping clinoform bedding, radiating paleocurrents, and the low to moderate degree of shallow-marine burrowing of sandstones within each allomember suggests that they are the deposits of top-truncated, mixed, river-influenced, wave-influenced, and tide-influenced deltas, and they are fed by river systems to the northwest, not offshore bars or shelf-ridge sandstones as previously interpreted.
3. Because no significant shoreline deposits were found farther seaward, the position of these sandstones in a distal-basin setting suggests that they are lowstand deltas associated with the time of maximum regression of the lower Belle Fourche sea.
4. Deltaic sandstones that prograded farther into the basin show a greater influence of wave processes on deposition and more open marine styles of bioturbation. Sandstones that prograded less far into the basin show more tide influence and are less bioturbated.
5. The lack of preserved delta-top deposits reflects significant marine ravinement during transgression of the deltaic shorelines.
6. Syndepositional deformation of the basin floor had a first-order control on patterns of sandstone deposition and the extent of subsequent ravinement. Subtle folds generated topography comparable with that produced by differential compaction around previously deposited sandstone bodies.
7. Major delta lobes are offset laterally within the basin rather than stacked vertically. Consequently, sequence stratigraphic sandstone stacking patterns can only be defined by examining the distribution of sandstone bodies in three dimensions and cannot be interpreted from a single vertical well log or cross section.

REFERENCES CITED

- Ainsworth, R. B., M. Sanlung, S. Theo, and C. Duivenvoorden, 1999, Correlation techniques, perforation strategies, and recovery factors: an integrated 3-D reservoir modeling approach, Sirkit field, Thailand: AAPG Bulletin, v. 83, p. 1535–1551.
- Alexander, J., 1989, Deltas or coastal plain? with an example of the controversy from the Middle Jurassic of Yorkshire, in M. K. G. Whateley and K. T. Pickering, eds., Deltas: sites and traps for

- fossil fuels: Geological Society Special Publication 41, p. 11–19.
- Barlow, J. A., and J. D. Haun, 1966, Regional stratigraphy of Frontier Formation and relation to Salt Creek field, Wyoming: AAPG Bulletin, v. 50, p. 2185–2196.
- Barrell, J., 1912, Criteria for the recognition of ancient delta deposits: Geological Society of America Bulletin, v. 23, p. 377–446.
- Beaumont, C. 1981, Foreland basins: Geophysical Journal of the Royal Society, v. 65, p. 291–329.
- Berg, R. R., 1975, Depositional environments of Upper Cretaceous Sussex Sandstone, House Creek field, Wyoming: AAPG Bulletin, v. 59, p. 2099–2110.
- Bergman, K. M., 1994, Shannon Sandstone in Hartzog Draw–Heldt Draw fields reinterpreted as detached lowstand shoreface deposits: Journal of Sedimentary Research, v. B64, p. 184–201.
- Bergman, K. M., and J. W. Snedden, eds., 1999, Isolated shallow marine sand bodies: sequence stratigraphic analysis and sedimentologic interpretation: SEPM Special Publication 64, 362 p.
- Bergman, K. M., and R. G. Walker, 1988, Formation of Cardium E5 erosion surface, and associated deposition of conglomerate; Carrot Creek field, Cretaceous Western Interior seaway, Alberta, in D. P. James and D. A. Leckie, eds., Sequences, stratigraphy, sedimentology, surface and subsurface: Canadian Society of Petroleum Geologists Memoir 15, p. 15–24.
- Berné, S., J. Durand, and O. Weber, 1991, Architecture of modern subtidal dunes (sand waves), Bay of Bourgneuf, France, in A. D. Miall and N. Tyler, eds., The three-dimensional facies architecture of terrigenous clastic sediments and its implications for hydrocarbon discovery and recovery: SEPM Concepts in Sedimentology and Paleontology, v. 3, p. 245–260.
- Bhattacharya, J. P., 1993, The expression and interpretation of marine flooding surfaces and erosional surfaces in core: examples from the Upper Cretaceous Dunvegan Formation, Alberta foreland basin, in H. W. Posamentier, C. P. Summerhayes, B. U. Haq, and G. P. Allen, eds., Sequence stratigraphy and facies association: International Association of Sedimentologists Special Publication 18, p. 125–160.
- Bhattacharya, J. P., and H. W. Posamentier, 1994, Sequence stratigraphic and allostratigraphic applications in the Alberta foreland basin, in G. D. Mossop and I. Shetsen, comp., Geological atlas of the Western Canada sedimentary basin: Canadian Society of Petroleum Geologists and Alberta Research Council, p. 407–412.
- Bhattacharya, J. P., and R. G. Walker, 1991, Allostratigraphic subdivision of the Upper Cretaceous Dunvegan, Shaftesbury, and Kaskapau formations in the subsurface of northwestern Alberta: Bulletin of Canadian Petroleum Geology, v. 39, p. 145–164.
- Bhattacharya, J. P., and R. G. Walker, 1992, Deltas, in R. G. Walker and N. P. James, eds., Facies models: response to sea-level change: Geological Association of Canada, p. 157–177.
- Blum, M. D., 1993, Genesis and architecture of incised valley fill sequences: late Quaternary example from the Colorado River, Gulf coastal plain of Texas, in P. Weimer and H. W. Posamentier, eds., Siliciclastic sequence stratigraphy, recent developments and applications, AAPG Memoir 58, p. 259–283.
- Brenner, R. L., 1980, Construction of process-response models for epicontinental seaway depositional systems using partial analogs: AAPG Bulletin, v. 64, p. 1223–1244.
- Clifton, H. E., R. E. Hunter, and R. L. Phillips, 1971, Depositional structures and processes in the non-barred, high energy near-shore: Journal of Sedimentary Petrology, v. 41, p. 651–670.
- Cloetingh, S., 1988, Intraplate stresses: a new element in basin analysis, in K. L. Kleinspehn and C. Paola, eds., New perspectives in basin analysis: New York, Springer-Verlag, p. 205–230.
- Cobban, W. A., E. A. Merewether, T. D. Fouch, and J. D. Obradovich, 1994, Some Cretaceous shorelines in the Western Interior of the United States, in M. V. Caputo, J. A. Peterson, and K. J. Franczyk, eds., Mesozoic systems of the Rocky Mountain region, U.S.A.: Rocky Mountain Section SEPM, p. 393–413.
- Coleman, J. M., and L. D. Wright, 1975, Modern river deltas: variability of processes and sand bodies, in M. L. Broussard, ed., Deltas, models for exploration: Houston, Texas, Houston Geological Society, p. 99–149.
- Corner, G. D., E. Nordahl, K. Munch-Ellingsen, and K. R. Robertson, 1990, Morphology and sedimentology of an emergent fjord-head Gilbert-type delta: Alta delta, Norway, in A. Collella and D. B. Prior, eds., Coarse grained deltas: International Association of Sedimentologists Special Publication 10, p. 155–168.
- Dalrymple, R. W., 1992, Tidal depositional systems, in R. G. Walker and N. P. James, eds., Facies models: response to sea-level change: Geological Association of Canada, p. 195–218.
- Donaldson, W. S., A. G. Plint, and F. J. Longstaffe, 1998, Basement tectonics control on distribution of the shallow marine Bad Heart Formation: Peace River arch area, northwest Alberta: Bulletin of Canadian Petroleum Geology, v. 46, p. 576–598.
- Dyman, T. S., E. A. Merewether, C. M. Molenaar, W. A. Cobban, J. D. Obradovich, R. J. Weimer, and W. A. Bryant, 1994, Stratigraphic transects for Cretaceous rocks, Rocky Mountains and Great Plains regions, in M. V. Caputo, J. A. Peterson, and K. J. Franczyk, eds., Mesozoic systems of the Rocky Mountain region, USA: Rocky Mountain Section SEPM, p. 265–292.
- Embry, A. F., 1993, Transgressive-regressive (T-R) sequence analysis of the Jurassic succession of the Sverdrup Basin, Canadian Arctic Archipelago: Canadian Journal of Earth Sciences, v. 30, p. 301–320.
- Embry, A. F., 1995, Sequence boundaries and sequence hierarchies: problems and proposals, in R. J. Steel, V. L. Felt, E. P. Johannessen, and C. Mathieu, eds., Sequence stratigraphy on the Northwest European margin: Norsk Petroleumsforening Special Publication 5, p. 1–11.
- Gingras, M. K., J. A. MacEachern, and S. G. Pemberton, 1998, A comparative analysis of the ichnology of wave- and river-dominated allomembers of the Upper Cretaceous Dunvegan Formation: Bulletin of Canadian Petroleum Geology, v. 46, p. 51–73.
- Hamlin, H. S., 1996, Frontier Formation stratigraphy on the Moxa Arch, Green River basin, Wyoming: The Mountain Geologist, v. 33, p. 35–44.
- Hart, B. S., and B. F. Long, 1996, Forced regressions and lowstand deltas: Holocene Canadian examples: Journal of Sedimentary Research, v. 66, p. 820–829.
- Hart, B. S., and A. G. Plint, 1990, Upper Cretaceous warping and fault movement on the southern flank of the Peace River arch, Alberta: Bulletin of Canadian Petroleum Geology, v. 38A, p. 190–195.
- Helland-Hansen, W., and J. G. Gjellberg, 1994, Conceptual basis and variability in sequence stratigraphy: a different perspective: Sedimentary Geology, v. 92, p. 31–52.
- Heller, P. L., F. Beekman, C. L. Angevine, and S. A. P. L. Cloetingh, 1993, Cause of tectonic reactivation and subtle uplifts in the Rocky Mountain region and its effect on the stratigraphic record: Geology, v. 21, p. 1003–1006.
- Hunt, D., and M. E. Tucker, 1992, Stranded parasequences and the forced regressive wedge systems tract: deposition during base-level fall: Sedimentary Geology, v. 81, p. 1–9.
- Huthnance, J. M., 1982, On one mechanism forming linear sand banks: Estuarine Marine Coastal Science, v. 14, p. 79–99.

- Jenette, D. C., and C. R. Jones, 1995, Sequence stratigraphy of the Upper Cretaceous Tooto sandstone: a model for tidally influenced incised valley, San Juan basin, New Mexico, *in* J. C. Van Wagoner and G. T. Bertram, eds., Sequence stratigraphy of foreland basin deposits: outcrop and subsurface examples from the Cretaceous of North America: AAPG Memoir 64, p. 311–347.
- Johnson, H. D., and C. T. Baldwin, 1996, Shallow clastic seas, *in* H. G. Reading, ed., Sedimentary environments: processes, facies and stratigraphy: Oxford, Blackwell Science, p. 232–280.
- Jordan, T. E., and P. B. Flemmings, 1991, Large-scale stratigraphic architecture, eustatic variation and unsteady tectonism: a theoretical evaluation: *Journal of Geophysical Research*, v. 96 B4, p. 6681–6699.
- Kolla, V., H. W. Posamentier, and H. Eichenseer, 1995, Stranded parasequences and the forced regressive wedge systems tract: deposition during base-level fall—discussion: *Sedimentary Geology*, v. 95, p. 139–145.
- Kraft, J. C., M. J. Chrzastowski, D. F. Belknap, M. A. Toscano, and C. H. Fletcher, 1987, The transgressive barrier-lagoon coast of Delaware: morphostratigraphic, sedimentary sequences and responses to relative sea level, *in* D. Nummedal, O. H. Pilkey, and J. D. Howard, eds., Sea-level fluctuations and coastal evolution: SEPM Special Publication 41, p. 129–143.
- La Fon, N. A., 1981, Offshore bar deposits of Semilla Sandstone Member of Mancos Shale (Upper Cretaceous), San Juan basin: AAPG Bulletin, v. 65, p. 706–721.
- Larue, D. K., 1995, Structurally aligned, sediment-starved fluvial valleys encased in marine deposits: sequence boundaries between the Carlisle shale and Niobrara Formation, central Powder River basin, U.S.A., *in* J. C. Van Wagoner and G. T. Bertram, eds., Sequence stratigraphy of foreland basin deposits: outcrop and subsurface examples from the Cretaceous of North America: AAPG Memoir 64, p. 371–394.
- Leckie, D. A., 1994, Canterbury Plains, New Zealand—implications for sequence stratigraphic models: AAPG Bulletin, v. 78, p. 1240–1256.
- MacEachern, J. A., and S. G. Pemberton, 1992, Ichnological aspects of Cretaceous shoreface successions and shoreface variability in the Western Interior seaway of North America, *in* S. G. Pemberton, ed., Applications of ichnology to petroleum exploration: SEPM Core Workshop 17, p. 57–84.
- Maguregui, J., and N. P. Tyler, 1991, Evolution of Middle Eocene tide-dominated deltaic sandstones, Lagunillas field, Maracaibo basin, western Venezuela, *in* A. D. Miall and N. Tyler, eds., The three-dimensional facies architecture of terrigenous clastic sediments and its implications for hydrocarbon discovery and recovery: SEPM Concepts in sedimentology and paleontology, v. 3, p. 233–244.
- Martinsen, R. S., and L. F. Krystinik, 1998, Depositional remnants: products of the interplay between synsedimentary tectonics and changes in relative sea level (abs.): AAPG Annual Convention Extended Abstracts, v. 2, p. A436.
- McCubbin, D. G., 1982, Barrier-island and strand-plain facies, *in* P. A. Scholle and D. R. Spearing, eds., Sandstone depositional environments: AAPG Memoir 31, p. 247–280.
- McGoogy, D. P., J. D. Haun, L. A. Hale, H. G. Goodell, D. G. McCubbin, R. J. Weimer, and G. R. Wulf, 1972, Cretaceous System, *in* W. W. Mallory, ed., Geological atlas of the Rocky Mountain region, United States of America: Rocky Mountain Association of Geologists, p. 190–228.
- Merewether, E. A., W. A. Cobban, and E. T. Cavanaugh, 1979, Frontier Formation and equivalent rocks in eastern Wyoming: *The Mountain Geologist*, v. 16, p. 67–101.
- Moslow, T. F. and S. G. Pemberton, 1988, An integrated approach to the sedimentological analysis of some lower Cretaceous shoreface and delta front sandstone sequences, *in* D. P. James and D. A. Leckie, eds., Sequences, stratigraphy, sedimentology; surface and subsurface: Canadian Society of Petroleum Geologists Memoir 15, p. 373–386.
- North American Commission of Stratigraphic Nomenclature (NACSN), 1983, North American stratigraphic code: AAPG Bulletin, v. 67, p. 841–875.
- Nummedal, D., and C. M. Molenaar, 1995, Sequence stratigraphy of ramp-setting strand plain successions: the Gallup Sandstone, New Mexico, *in* J. C. Van Wagoner and G. T. Bertram, eds., Sequence stratigraphy of foreland basin deposits: outcrop and subsurface examples from the Cretaceous of North America: AAPG Memoir 64, p. 277–310.
- Nummedal, D., and G. W. Riley, 1991, Origin of late Turonian and Coniacian unconformities in the San Juan basin, *in* J. C. Van Wagoner, D. Nummedal, C. R. Jones, D. R. Taylor, D. C. Jennette, and G. W. Riley, eds., Sequence stratigraphy applications to shelf sandstone reservoirs: outcrop to subsurface examples: AAPG Field Conference Guide, 275 p.
- Nummedal, D., and G. W. Riley, 1999, The origin of the Tooto Sandstone and its sequence stratigraphic lessons, *in* K. M. Bergman and J. W. Snedden, eds., Isolated shallow marine sand bodies: sequence stratigraphic analysis and sedimentologic interpretation: SEPM Special Publication 64, p. 227–354.
- Nummedal, D., and D. J. P. Swift, 1987, Transgressive stratigraphy at sequence-bounding unconformities: some principles derived from Holocene and Cretaceous examples, *in* D. Nummedal, O. H. Pilkey, and J. D. Howard, eds., Sea-level fluctuations and coastal evolution: SEPM Special Publication 41, p. 241–260.
- Obradovich, J. 1993. A Cretaceous time scale, *in* W. G. E. Caldwell and E. G. Kauffman, eds., Evolution of the Western Interior basin: Geological Association of Canada Special Paper 39, p. 379–396.
- Palmer, J. J., and A. J. Scott, 1984, Stacked shoreline and shelf sandstones of La Ventana Tongue (Campanian) northwestern New Mexico: AAPG Bulletin, v. 68, p. 74–91.
- Parker, G., 1999, Maps: it's the basement's fault: *Geophysical Corner*, AAPG Explorer, v. 20, p. 28–31.
- Pemberton, S. G., and D. M. Wightman, 1992, Ichnological characteristics of brackish water deposits, *in* S. G. Pemberton, ed., Applications of ichnology to petroleum exploration: a core workshop: SEPM Core Workshop 17, p. 141–167.
- Pemberton, S. G., J. A. MacEachern, and R. W. Frey, 1992, Trace fossil models: environmental and allostratigraphic significance, *in* R. G. Walker and N. P. James eds., Facies models: response to sea level change: Geological Association of Canada, p. 47–72.
- Plint, A. G., 1988, Sharp-based shoreface sequences and “offshore bars” in the Cardium Formation of Alberta: their relationship to relative changes in sea level, *in* C. K. Wilgus, B. S. Hastings, C. G. St. C. Kendall, H. W. Posamentier, C. A. Ross, and J. C. Van Wagoner, eds., Sea-level changes: an integrated approach: SEPM Special Publication 42, p. 357–370.
- Plint, A. G., B. S. Hart, and W. S. Donaldson, 1993, Lithospheric flexure as a control on stratal geometry and facies distribution in Upper Cretaceous rocks of the Alberta foreland basin: *Basin Research*, v. 5, p. 69–77.
- Posamentier, H. W., and C. J. Chamberlain, 1993, Sequence stratigraphic analysis of Viking Formation lowstand beach deposits at Joarcam field, Alberta, Canada, *in* H. W. Posamentier, C. P. Summerhayes, B. U. Haq, and G. P. Allen, eds., Sequence

- stratigraphy and facies associations: International Association of Sedimentologists Special Publication 18, p. 469–485.
- Posamentier, H. W., and D. P. James, 1993, An overview of sequence stratigraphic concepts: uses and abuses, *in* H. W. Posamentier, C. P. Summerhayes, B. U. Haq, and G. P. Allen, eds., Sequence stratigraphy and facies associations: International Association of Sedimentologists Special Publication 18, p. 3–18.
- Posamentier, H. W., G. P. Allen, D. P. James, and M. Tesson, 1992, Forced regressions in a sequence stratigraphic framework: concepts, examples, and exploration significance: AAPG Bulletin, v. 76, p. 1687–1709.
- Reinson, G. E., 1992, Transgressive barrier islands and estuarine systems, *in* R. G. Walker and N. P. James, eds., Facies models: response to sea level change: Geological Association of Canada, p. 179–194.
- Rice, D. D., 1985, Widespread, shallow marine, storm-generated sandstone units in the Upper Cretaceous Mosby Sandstone, central Montana, *in* R. W. Tillman and C. T. Siemers, eds., Siliciclastic shelf sediments: SEPM Special Publication 34, p. 143–161.
- Scheihing, M. H., and G. C. Gaynor, 1991, The shelf sand-plume model: a critique: Sedimentology, v. 38, p. 433–444.
- Shurr, G. W., 1984, Geometry of shelf-sandstone bodies in the Shannon Sandstone of southeastern Montana, *in* R. W. Tillman and C. T. Siemers, eds., Siliciclastic shelf sediments: SEPM Special Publication 34, p. 63–83.
- Snedden, J. W., and K. M. Bergman, 1999, Isolated shallow marine sand bodies: deposits for all interpretations, *in* K. M. Bergman and J. W. Snedden, eds., Isolated shallow marine sand bodies: sequence stratigraphic analysis and sedimentologic interpretation: SEPM Special Publication 64, p. 1–12.
- Snedden, J. W., and R. W. Dalrymple, 1999, Modern shelf sand ridges: historical review of modern examples and a unified model of ridge origin and evolution, *in* K. M. Bergman and J. W. Snedden, eds., Isolated shallow marine sand bodies: sequence stratigraphic analysis and sedimentologic interpretation: SEPM Special Publication 64, p. 13–28.
- Sullivan, M. D., J. C. Van Wagoner, M. E. Foster, R. M. Stuart, D. C. Jenette, R. W. Lovell, and S. G. Pemberton, 1995, Lowstand architecture and sequence stratigraphic control on Shannon incised-valley distribution, Hartzog Draw field, Wyoming, *in* R. O. Fitzsimmons, B. Parsons, and D. J. P. Swift, eds., Tongues, ridges and wedges: highstand versus lowstand architecture in marine basins: SEPM Research Conference Field Guide, p. 125–137.
- Sullivan, M. D., J. C. Van Wagoner, D. C. Jenette, M. E. Foster, R. M. Stuart, R. W. Lovell, and S. G. Pemberton, 1997, High resolution sequence stratigraphy and architecture of the Shannon Sandstone, Hartzog Draw field, Wyoming: implications for reservoir management, *in* K. W. Shanley and B. F. Perkins, eds., Shallow marine and nonmarine reservoirs, sequence stratigraphy, reservoir architecture and production characteristics: Gulf Coast Section SEPM Eighteenth Annual Research Conference, p. 331–344.
- Swift, D. J. P., J. W. Snedden, and A. G. Plint, eds., 1995, Tongues, ridges and wedges: highstand versus lowstand architecture in marine basins: SEPM Research Conference Program, variably paginated.
- Taylor, D. R., and R. W. Lovell, 1995, High-frequency sequence stratigraphy and paleogeography of the Kenilworth member, Blackhawk Formation, Book Cliffs, Utah, U.S.A., *in* J. C. Van Wagoner and G. T. Bertram, eds., Sequence stratigraphy of foreland basin deposits: outcrop and subsurface examples from the Cretaceous of North America: AAPG Memoir 64, p. 257–275.
- Tesson, M., H. W. Posamentier, and B. Gensous, 2000, Stratigraphic organization of late Pleistocene deposits of the western part of the Golfe du Lion Shelf (Langedoc Shelf), western Mediterranean Sea, using high-resolution seismic and core data: AAPG Bulletin, v. 84, p. 119–150.
- Tillman, R. W., 1994, Valley-fill and shelf-ridge sandstones of Cenomanian age, Frontier Formation, central Wyoming (abs): AAPG Annual Convention, Program with Abstracts, v. 3, p. 271.
- Tillman, R. W., and R. S. Martinsen, 1985, The Shannon shelf-ridge sandstone complex, Salt Creek anticline area, Powder River basin, Wyoming, *in* R. W. Tillman and C. T. Siemers, eds., Siliciclastic shelf sediments: SEPM Special Publication 34, p. 85–142.
- Tillman, R. W., and E. A. Merewether, 1994, Field guide for valley-fill, estuarine, and shelf ridge sandstones, mid-Cretaceous Frontier Formation, central Wyoming: AAPG Annual Meeting Field Trip Guidebook, 90 p.
- Tillman, R. W., and E. A. Merewether, 1998, Valley-fill, estuarine, and shelf ridge sandstones, mid-Cretaceous Frontier Formation, central Wyoming (abs.): AAPG Annual Meeting Extended Abstracts, v. 2, A657, p. 1–4.
- Trincardi, F., and M. E. Field, 1991, Geometry, lateral variation, and preservation of downlapping regressive shelf deposits: eastern Tyrrhenian Sea margin, Italy: Journal of Sedimentary Petrology, v. 61, p. 775–790.
- Tye, R. S., J. P. Bhattacharya, J. A. Lorsche, S. T. Sindelar, D. G. Knock, D. D. Puls, and R. A. Levinson, 1999, Geology and stratigraphy of fluvio-deltaic deposits in the Ivishak Formation: applications for development of Prudhoe Bay field, Alaska: AAPG Bulletin, v. 83, p. 1588–1623.
- Valasek, D., 1995, The Tocito Sandstone in a sequence stratigraphic framework: an example of landward-stepping small-scale genetic sequences, *in* J. C. Van Wagoner and G. T. Bertram, eds., Sequence stratigraphy of foreland basin deposits: outcrop and subsurface examples from the Cretaceous of North America: AAPG Memoir 64, p. 349–369.
- Van Wagoner, J. C., 1995, Sequence stratigraphy and marine to nonmarine facies architecture of foreland basin strata, Book Cliffs, Utah, U.S.A., *in* J. C. Van Wagoner and G. T. Bertram, eds., Sequence stratigraphy of foreland basin deposits: outcrop and subsurface examples from the Cretaceous of North America: AAPG Memoir 64, p. 137–223.
- Van Wagoner, J. C., R. M. Mitchum, K. M. Campion, and V. D. Rahmanian, 1990, Siliciclastic sequence stratigraphy in well logs, cores, and outcrops: concepts for high-resolution correlation of time and facies: AAPG Methods in Exploration Series 7, 55 p.
- Walker, R. G., 1984, Shelf and shallow marine sands, *in* R. G. Walker, ed., Facies models, 2d ed.: Geoscience Canada Reprint Series 1, p. 141–170.
- Walker, R. G., 1990, Perspective, facies modelling and sequence stratigraphy: Journal of Sedimentary Petrology, v. 60, p. 777–786.
- Walker, R. G., 1995, Sedimentary and tectonic origin of a transgressive surface of erosion: Viking Formation, Alberta, Canada: Journal of Sedimentary Research, v. B65, p. 209–221.
- Walker, R. G., and K. M. Bergman, 1993, Shannon Sandstone in Wyoming: a shelf-ridge complex reinterpreted as lowstand shoreface deposits: Journal of Sedimentary Petrology, v. 63., p. 839–851.
- Walker, R. G., and A. G. Plint, 1992, Wave- and storm-dominated shallow marine systems, *in* R. G. Walker and N. P. James, eds., Facies models: response to sea-level change: Geological Association of Canada, p. 219–238.
- Williams, G. D., and C. R. Stelck, 1975, Speculations on the Cretaceous paleogeography of North America, *in* W. G. E.

- Caldwell, ed., The Cretaceous System in the Western Interior of North America: Geological Association of Canada Special Paper 13, p. 1–20.
- Willis, B. J., J. P. Bhattacharya, S. L. Gabel, and C. D. White, 1999. Architecture of a tide-influenced delta in the Frontier Formation of central Wyoming, USA: *Sedimentology*, v. 46, p. 667–688.
- Winn, R. D., 1991, Storm deposition in marine sand sheets: Wall Creek Member, Frontier Formation, Powder River basin, Wyoming: *Journal of Sedimentary Petrology*, v. 61, p. 86–101.